

De Vonk



Periodical of  E.T.S.V. Scintilla



TwenteSat

IAC 2013

Cognitive Radio

Crosscorrelation Spectrum Sensing
for Dynamic Spectrum Access

Afterlife

Uncertified succes



In Memoriam



To our great regret we have had
to say farewell to

Dewi Bohlmeijer

1994 - 2013

Facing a challenge

Author: Robert Fennis



The study year 2013/2014 will be a unique and challenging year for both the students and this association. First of all, the new educational model is officially integrated in all the universities programs. Secondly the government is changing their policies again considering scholarship. In the recoil of these financial cuts, students were too hesitant to spend too much of their time in side activities like the board resulting in a big shortcoming of volunteers.

Luckily there is one bright star shining through the dark clouds. One heroin willing to spend one year of her life serving not only as the backbone and exoskeleton of our financial critter, but also as the new wailing wall of the students taking care of all of the complaints about our education. One descendant of Educational Sciences called Dieuwertje ten Berg with whom I have the honor of working with. Karim Kok is once again the administrator of the STORES. Erik de Wit is the last person we needed to satisfy the demands of our regulations, willing to sign a contract stating that he could be held responsible for Scintilla. I am very grateful to work with this team the upcoming year and I'm looking forward to it!

When we started we immediately noticed how much work is ahead of us. Not only big tasks but also the small ones are draining a lot of our time. After a few weeks of having to clean up people their mess on our balcony, our members automatically started helping us out with our daily chores. Amazing!! I want to thank everybody who is helping us out for their time and I also want to personally thank everybody who is not too lazy to rinse their coffee mugs and throw

away teabags, coffee spoons, sugar bags and every other thinkable food encapsulations in the trash bins that are located literally 20 cm away from the places where everybody else is dumping their waste.

Enough of that. The first weeks were not only busy but also very fun! A lot of constitution drinks helped me to train my beer muscle. After gaining way to much pounds its time to start losing them. After all, I have to be able to run those 7km without leaving too much craters in the pavement. All in all, one amazing year ahead of us! The new students al seem to be very cool and I'm really looking forward to making this a fun year!

Op de koningin, op Scintilla!

Robert Fennis,
President of E.T.S.V. Scintilla

Wine tasting evening
Thursday 21 November
20:00h, Abscint

MILFBA
Thursday 28 November
18:00h, Abscint

Scinterklaas evening
Wednesday 4 December
16:00h, Abscint

Christmas-dinner
Thursday 19 December
19:00h, Abscint

Masthead

De Vonk

Periodical of E.T.S.V. Scintilla.
Published four times a year in the amount of 630 copies.

Year 32, edition 1
December 2013

Editorial team

Tim Broenink, Erwin Bronkhorst,
Arno Geurts, Fieke Hillerström,
Maikel Huiskamp, Vera Nauta,
Rowan de Vries.

Print

Gildeprint, Enschede

Editorial office

E.T.S.V. Scintilla, University of Twente,
Postbus 217, 7500 AE Enschede,
☎ 0031 53 489 2810
☎ 0031 53 489 1068
vonk@scintilla.utwente.nl

Material

vonkkopij@scintilla.utwente.nl

All members of Scintilla receive De Vonk free of charge by post.

Nothing in this magazine may be duplicated or copied without explicit permission from the editorial team of De Vonk.

The editorial team reserves the right to change or exclude material provided by third parties, in part or in whole. The opinions expressed in the articles are not necessarily shared by the editorial team.

ISSN 0925-5421



8. The 84th Board

It was not an easy job to find them, but Scintilla finally got them: a new board for the coming year. Last year, the board was presented to you in a tale of the five knights, this year you can read about the new board in the tale of the two musketeers. How did they come in the position they are today and what can we expect from them?

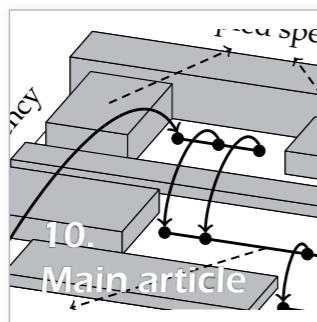

10. Main article

The main article in this Vonk comes from the chair 'ICD'. In this article, with the title "Crosscorrelation Spectrum Sensing for Dynamic Spectrum Access", you can read everything about wireless communications, bandwidth and frequency spectrums. Why is the speed of a 3G network limited and how fast can we go with new wireless technologies? Mark Oude Alink will answer these questions.

In this edition of Afterlife, you can read another story about how your life might look like after a study Electrical Engineering. Maarten Segers, who used to be an EE student and active member of Scintilla, tells his story. Nowadays, he works at a company in Amsterdam. How did Maarten 'finish' his study and how did life go for him after he stopped?



16. Afterlife

If you have ever visited the Scintilla Chamber in the Zilverling, you may have noticed the small computers attached on the back of each monitor. These so-called thin clients are used as a full workstation on a daily basis, but they lack strong processing power, a lot of memory and even a physical hard drive. In this article, Koen of Scintilla Operator Team explains how these systems work.



24. Thin Clients

Editorial

A game with two sides

Soccer, it is probably the best known and most popular sport in the world. According to Wikipedia the game is played by two teams with eleven players on a rectangular field with a spherical ball. That it is very popular is noticeable when you are new somewhere. You introduce yourself, make small talk and most of the time the subject of soccer pops up. Personally I could not care less which team kicks the most spherical balls in a goal, so most of the times I will nod my head until the subject changes.

That the sport is very popular is also noticeable when the national team has to play. Streets turn orange, the countries national color, and almost the entire country is confined to the television. We flock to the country where the game is played and turn it orange. It may seem strange to the rest of the world, but at least this happening is peaceful. What Wikipedia does not mention is what sometimes seems to be the second goal of soccer: Hooliganism.

Apparently it is "fun" to destroy city centers, cars and beat up people. Sometimes it seems martial law is applied when games are played in some cities. There are policeman on every corner and during some games it won't take long before the riot control heads out to sweep the streets clean. Once I could not enter my own city without proper identification when "our" club had to play against our arch enemy. Riot control was at the bridge blocking the entrance to the city because apparently it was needed.

A little bird told me that Scintilla apparently has a new soccer team. I want to wish them luck and may you kick more spherical balls in your opponent's goal than they do in yours.

3

Presidential note
Facing a Challenge

6

News
News for the Electrical Engineer

8

The 84th board
Tale of the two musketeers

10

Main article
Crosscorrelation Spectrum Sensing for Dynamic Spectrum Access

16

Afterlife
Uncertified succes

18

Advertorial Thales
Een interview met Tom Griffioen en Hugo Anbeek

20

Photo pages

22

Bachelor assignment
Bobby on wheels

SOT

*Scintillas thinclient
How SOT does it*

MEEKI

Master Kick-In

Junction
Tjark Post

Baking pies
Solar powered baking

TwenteSat
IAC2013

Advertorial Liander
Network automation

Puuzle

25

28

30

32

34

37

38

News for the Electrical Engineer

Author: Maikel Huiskamp

Nanotube computer integrated with CMOS for the first time

For the first time a working computer using carbon nanotube transistors on a silicon wafer was demonstrated by the researchers at Stanford University. The researchers used a so called "imperfection-immune design" to overcome the main difficulties when producing carbon-based semiconductors in a CMOS design process. A couple of decades ago the carbon nanotubes were pushed as the new and ideal transistor because of their higher speed and lower power consumption than their CMOS equivalents. There were a couple of problems with the carbon nanotubes that prevented them from being used, the inability to grow them in straight lines and the difficulty of sorting out semiconducting

from metallic nanotubes. To circumvent these problems the researchers used their so called "imperfection-immune design". In this approach nanotubes are grown on quartz with vapor deposition on which 99.5% of all the nanotubes grow in a straight line. These grown nanotubes are then placed on a CMOS wafer. Even when 99.5% of all the transistors are ok this would normally still result in an unacceptable number of defects. To solve this problem the researchers use a circuit layout technique that etches out pre-defined regions for specific functions using graph-theoretic algorithms. This results in the imperfection-immune standard cells

that use the same design infrastructure as normal CMOS logic. The researchers from Stanford were able to create a working RISC CPU using 178 nanotubes that can execute 20 instructions.

Source: http://www.eetimes.com/document.asp?doc_id=1319660

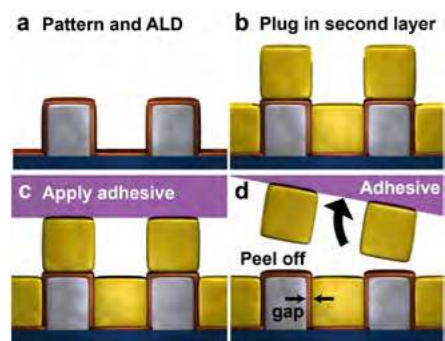
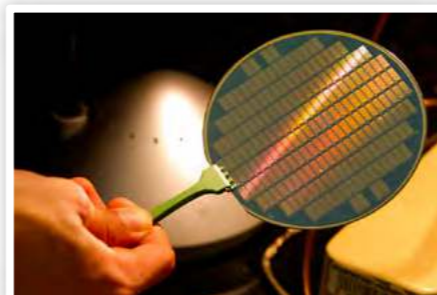

Source: http://www1.umn.edu/news/news-releases/2013/UR_CONTENT_455024.html

Tape used for electronics manufacturing

Scientists from the University of Minnesota have discovered a technique for the manufacturing of nanostructures that uses Scotch Magic tape. This technique has the potential to make electrical and optical devices smaller. Combining several standard nanofabrication techniques and tape the researchers were able to create tiny gaps over the surface of a silicon wafer, where the smallest gap was 1nm wide. The width of the gaps could in addition be controlled to the atomic level. The most surprising outcome of

the research is that tape is one of the key elements in realizing the small gaps. Etching the one nanometer wide gaps is not yet feasible with the existing tools. The nano gaps were constructed by layering atomic-scale thin films on the sides of the structures and then capping the structure with another metal layer. The challenging part was to remove the excess metals on top and expose the structures below. The researchers found out that this can be done with tape.

MIT constructs self-assembling robots

Researchers at MIT constructed small cubical robots that can form any arbitrary shape. The cubes are capable of propelling themselves forward, jump on each other and snap together to do self-assembly. The cubes known as M-blocks have no external moving parts. The movement of the M-blocks comes from an internal flywheel that reaches up to 20,000 revolutions per minute. When the flywheel is braked it imparts its angular momentum to the cube to make it move forward. On each edge of the M-block there are permanent magnets that allow cubes to attach to each other.

In the research for reconfigurable robots researchers have long used an abstraction called the sliding-cube model. If two cubes are facing each other than one robot can slide over the other one. This model is meant to simplify the development of self-assembly algorithms. Already existing modular-robot systems can stop their motion any time they want, which makes it a "statically stable" system. The new system of the MIT researches is not statically stable since at some point the robots actually fly through the air. To compensate for the static instability the researchers placed cylindrical magnets on each edge that automatically rotate when two cubes approach one another. This way the north and south poles are aligned and every face can be connected to any other face of the cubes.

To further increase the grip when a cube flips onto another the edges are also beveled. This way when one cube flips on top of another the bevels and magnets touch, thus increasing the connection strength between cubes.

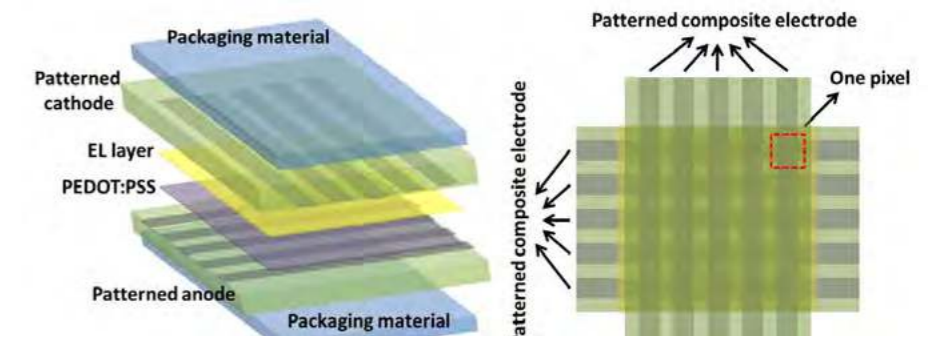

Stretchable OLEDs developed for displays

Researchers at the University of California demonstrated an elastic OLED prototype. The stretchable OLED displays could be used in smartphones, electronic clothing or wallpaper like lighting. To accomplish the stretchable and bendable OLED the researchers had to change and reengineer all the materials in the OLED stack. The two key elements were the development of a transparent compliant conductor and a light-emitting electrochemical cell that consists of a mixture of electronic semiconductors and an ionic conductor. The light emitting electrochemical cell is

sandwiched between the transparent silver nanowires composite electrodes made from a rubber-like polymer. In the prototype the electrode layers were patterned into rows on top and columns on the bottom layer, thus enabling each pixel to be addressed separately. To prove the concept two small stretchable OLEDs were fabricated, one lighting panel and the other one a passive 5x5 pixel display. The both survived over 1000 trials of stretching 30 percent larger than their original size and 180 degrees bends.

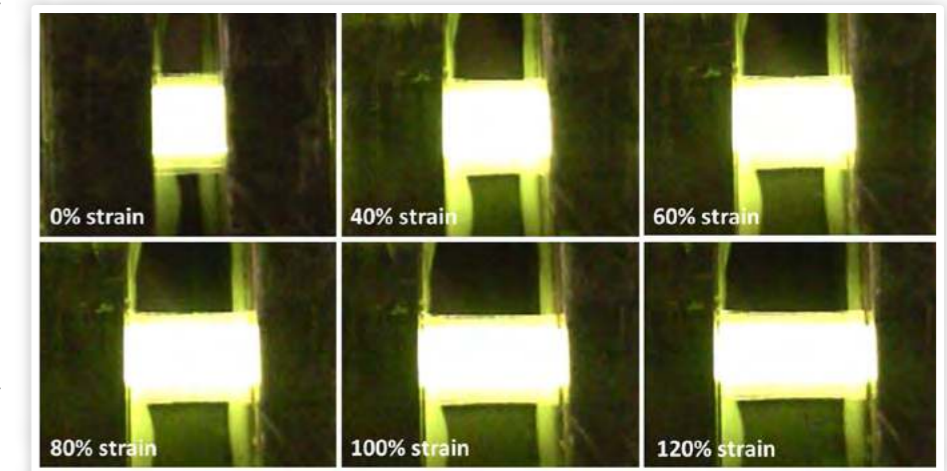

Encrypted implants keep hackers out.

Modern medical devices such as defibrillators and insulin pumps now include wireless connections that allow a doctor or technician to update the software or download data that can be used for medical purposes, but could also be misused by hackers. Security researchers showed that it is possible to reprogram the devices such as the defibrillator to stay inactive or give a 700-volt shock when it is not needed. A solution to this problem is to use the

heartbeat of the patient as verification if someone is in direct contact with the patient or not. In this method the doctor holds an device against the patient's body that reads the heartbeat and compares it with the heartbeat that is relayed in the wireless signal from the implant.

Source: <http://www.technologyreview.com/news/519266/encrypted-heartbeats-keep-hackers-from-medical-implants/>

The 84th board

Tale of the two musketeers

Once upon a time in the east of the country, there was a silver castle. The silver castle was the home of a specific group of students and their student association. Last year the castle was protected by five brave knights, but the five brave knights were nowhere to be found. The knights had to be found, and this is the story of the musketeers on their quest to save the knights.

There was one musketeer who was immediately ready for the challenge. He was ready for a new challenge, he was waiting for action. This brave young man is called Fennis. It seems to be that he also listens to a different name, but that will only bring confusion.

The young musketeer was walking through the woods, he was following a trail of little white stones. He walked for days and

nights, and he had almost lost all hope of ever finding anything when he heard some voices. He heard three voices, two he recognized, one he didn't. The voices he didn't know sounded old, and not very nice. It was an old witch and she was commanding a person to clean and cook. When Fennis got closer to the house he saw that it was made of candy. He also saw that knight Luuk and knight Koen were there. Knight Koen was

locked up in a cage, surrounded by food, and knight Luuk was cleaning the house. The witch was stirring in her kettle. "Is he ready to be cooked?" the witch wanted to know. "Is he already fat enough?" Luuk answered: "no, not yet milady".

Fennis thought; this is not right. He rushed to the house, killed the witch and freed Luuk and Koen. Koen and Luuk were very

Author: The 84th board



happy with their freedom. And Fennis was declared a freedomfighter of the Silver castle. He took the two knights back to the castle, where they could rest and get strong before the new year started. Before he left the knights gave him the advice to go the west. So he rode to the west. It was a long journey, he met many people and fought many battles before he entered into the new woods. The woods used to be a nice, kind looking place, but now it was terrorized by a evil wolf called TOM. Fennis heard of this monster and was planning to kill it.

But in the woods lived a girl with a red cloak and her grandmother. Their family had lived in the woods for many generations. They protected the woods and the creatures that lived in the woods. They took good care of the habitants in the woods. But Tom the wolf was getting more and more problematic, so the girl in red, named Dieuwertje, was done with the wolf problem. The wolf should not be causing so much trouble, it should live in peace. But her family had sworn an oath to protect the animals and not to kill them. So the wolf had to be tamed.

So Dieuwertje rode out to tame the wolf. After a few days she found the wolf, and the taming process began. She was training the wolf for two weeks when she heard a strange noise in the night. She woke up and took her armor. When she got outside she saw a

musketeer, fighting with the wolf. "Watch out" the musketeer shouted, "the wolf is evil!". "No, it is not!" she shouted back, and she stepped in front of the wolf. The oath to the wood and its habitants was explained and Fennis the musketeer understood why the wolf had to live.

Both the musketeer and the girl in red had tasted the world of heroism and were not ready to stop living the heroic life. So they strode together to save the world. In one of the villages they passed, a story was told. It was the story of a blond princess, captured in a tower. An evil witch stole her from her parents and captured her in a tower. She must be saved, the two thought. So after a journey of weeks they found the tower. Hidden in a far away country, they found the princess. She was high up in tower, locked away for anyone to see. The two musketeers tried to get into the tower, but that was not so easy. One day the witch came, and the princess let her hair down, and the witch climbed up to the window. When the witch was gone, the musketeers asked the princess to let her hair down. The princess her name was Laurie, and she was desperate to get out. She was rescued and bought back to the silver castle.

In the silver castle she met Koen and Luuk, her long lost friends. While the musketeers were off saving the princess a different kind of horrific event had taken place. The two

sons of the goldsmith were kidnapped. They were twins, one, Tim, was very well spoken and knew how to play people so that they would do anything for him. His brother, Mattanja, was the guardian of the money and the jewels they gathered. In their heart they were good men, but they were forced to use their talents for evil business. The goldsmith was a well respected man in the silver castle, so the musketeers rode out to save his sons.

So the musketeers were searching for the twins, they were kidnapped by a traveling circus. But the musketeers didn't give up, and they were halfway on their way to Japan when they found the circus. They pretended that they wanted to join the circus and gained their trust. And one night, they ran away with Tim and Mattanja. The twins were very happy to go back home, and to be reunited with their friends from the silver castle.

All the knights were back in the silver castle. But after these traumatizing experiences they were in need of rest, so new protectors had to be found. The two musketeers were up for the task. They had proven their dedication while saving the knights.

So the castle was again protected for a year, by the brave musketeers named Fennis and Dieuwertje.

Crosscorrelation Spectrum Sensing for Dynamic Spectrum Access

Author: Mark Oude Alink

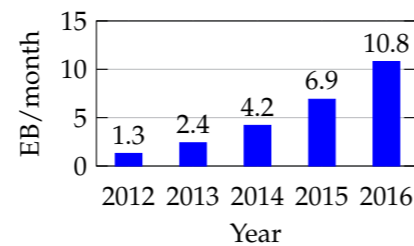
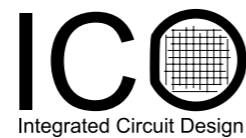

Figure 1: Wireless cell phone data demand in exabytes per month for recent history and near future (1EB=10¹⁸ bytes).

transmission power, and the fact that walls and other obstacles severely attenuate the signal. This is great to avoid interference with your neighbors, but not so great if you want a good connection and mobility everywhere you go.

Have you ever wondered why the datarate on your 3G connection is typically limited to just a few Mbit/s? It is basically limited by three factors: (1) limited bandwidth, (2) limited spatial reuse, and (3) limited spectral efficiency.

Currently, spatial reuse is aggressively improved by operators using cell splitting: there are more (but smaller) masts to provide an area with coverage. In that way, the same frequency can be reused more often, which effectively means that each user can get a larger portion of the capacity of each cell.

LTE (also known as 4G) is currently being rolled out in the Netherlands. Compared to 3G, it improves on spectral efficiency as well as bandwidth. Where UMTS uses only 5MHz of spectrum per channel, LTE increases this to 20MHz (and even 40MHz in the near future). LTE increases spectral efficiency by using 64-QAM, which puts three times as many bits per second in the same spectrum as QPSK, which is used in UMTS.

But even this increase will only be enough for a few years. Predictions are that the de-

mand for wireless data communications continues to increase by 75% each year, see fig. 1. Squeezing more bits into the same spectrum is very inefficient in terms of power consumption, and we all know that battery life is already an issue in our smartphones. The increase in number of cells is also limited by cost and practical constraints. So in the end, the only viable way to improve the capacity even further is to use more spectrum.

Unfortunately, virtually all of the usable spectrum below 6GHz has been assigned, which makes it very hard for new services to squeeze in. There is a lot more room at higher frequencies. For example, the first commercial products of IEEE 802.11ad (WiFi at 60GHz) are expected in 2014 and promise up to 7Gb/s. The downsides at such high frequencies are the much smaller distances that can be covered for the same

Dynamic Spectrum Access

There is an alternative way to get access to more spectrum, known as Dynamic Spectrum Access (DSA). Measurements show that only 2% to 20% of the spectrum below 3GHz is actively being used at any given time and location, even in major cities. An example of such a measurement is shown in fig. 2, made by Swisscom in Bern. Thus, although spectrum is a scarce resource, it is used in a very inefficient way. DSA promises a much more efficient use of the spectrum by letting unlicensed users opportunistically use bands that are licensed to primary users (PUs), but are temporarily and/or locally unused, known as 'spectrum holes' or 'white space', see fig. 3.

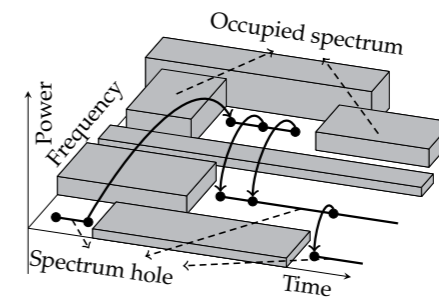

Figure 3: Dynamic spectrum access opportunistically uses unused spectrum

new year, or for (HD)TV streaming to your smartphone.

Public safety services tend to have a very high peak-to-average utilization, which means that their dedicated spectrum

Detecting these spectrum holes is one of the main challenges in DSA. It is in principle possible to use databases to hold this information, but that requires additional infrastructure, and may not work for ad-hoc networks or bands with rapidly changing occupancy. Therefore, many people focus on spectrum sensing, which measures the current occupancy of the spectrum to determine which bands are available to use. One can distinguish between several main categories of spectrum sensing, such as coherent sensing, cyclostationary sensing, and energy detection. The first two categories exploit known properties of the signal, which improves the signal-to-noise ratio (SNR) and thereby offers better detection performance. Unfortunately, this will be more difficult for bands that have many different and perhaps many unknown modu-

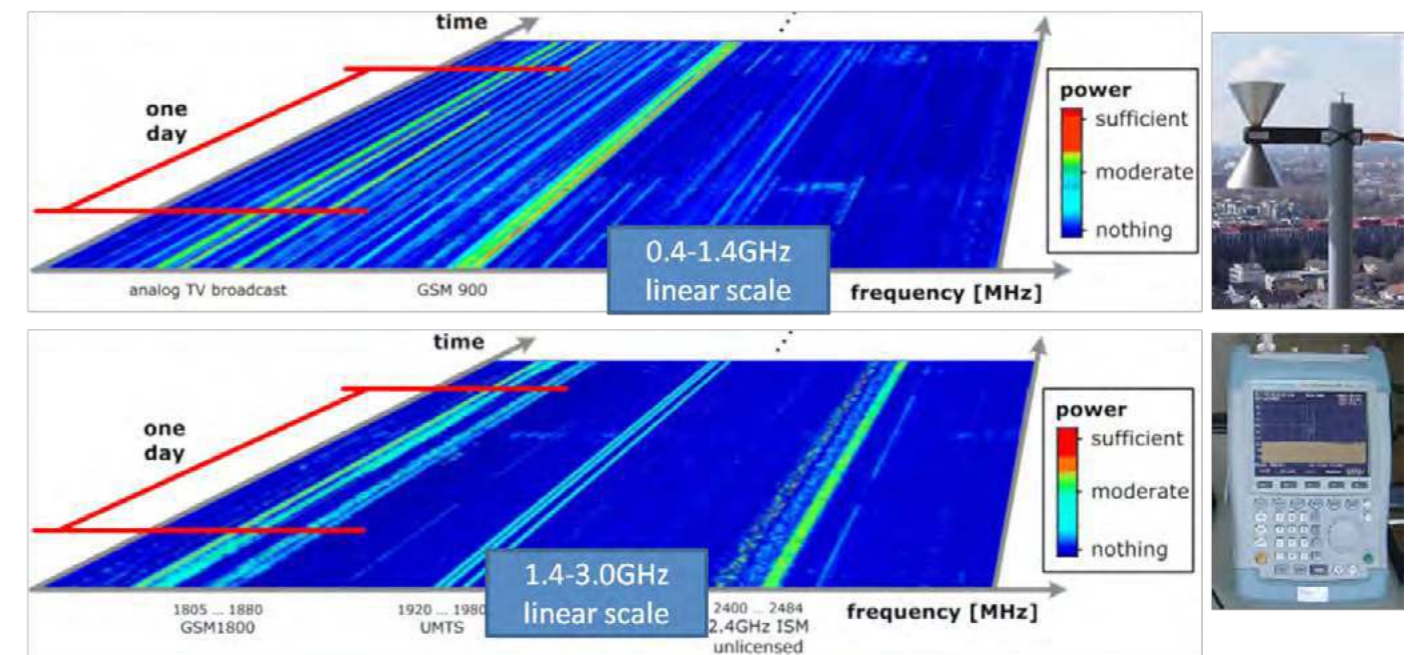

Figure 2: Spectrum measurements in Bern (and many others) show that although virtually all of the spectrum has been assigned, the actual usage is rather low in most bands. (Source: Swisscom)

One of the main drivers of DSA is the possibility to get broadband wireless internet to areas that are too remote or geographically difficult to reach via a wired network. By using the sub-GHz frequencies, one can easily cover tens of kilometers at reasonable transmission powers. DSA would also allow any wireless connection to offload peak demands to other parts of the spectrum, thereby allowing it to obtain a higher datarate when it needs it. This is a useful feature for the GSM-network in the first hour of the

remains largely unused for most of the time. When they do need spectrum, they actually need more than what is assigned to them. Think of the many rescue workers that had to communicate with each other after the fireworks disaster in Enschede in 2000. Moreover, the addition of multimedia transfer, such as photos and video, could be of great help in saving lives. DSA can also enable rescue workers inside buildings to switch to more favorable frequencies to prevent losing connection.

lation formats. Moreover, these algorithms tend to be quite computationally complex. Therefore, my focus is on energy detection (ED), which does not rely on any knowledge of the signals to be detected, and can thus be used anywhere in any band.

Energy detection

ED measures the power (or energy, hence the name) in a frequency band to decide

whether a signal is present or not. The detector has to decide, based on the digital complex baseband receiver output $r[k]$ (if you don't know what that means, think of it as the waveform as shown on the screen of an oscilloscope), which of the following two hypotheses is true:

$$H_0 : r[k] = n[k] \text{ (measuring only noise)}$$

$$H_1 : r[k] = s[k] + n[k] \text{ (measuring signal plus noise)}$$

This is done by estimating the power (or energy) of $r[k]$ using K samples. The standard means to do this is a form of autocorrelation (AC). For those of you familiar with this term, the autocorrelation function at lag 0 is calculated. The process is visualized in fig. 4, and the equation reads

$$\hat{P}_{ac} = Y = \frac{1}{K} \sum_{k=0}^{K-1} |r[k]|^2$$

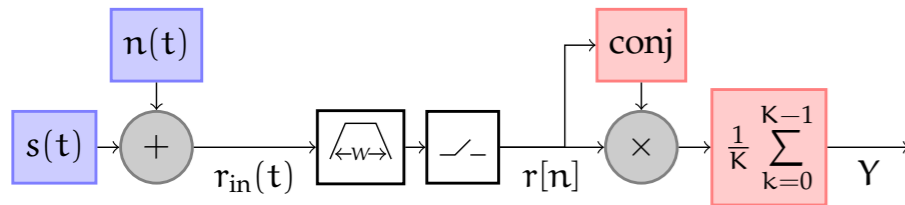

Figure 4: Principle of energy detection: receive noise plus a signal (or just noise), filter it to only look at a certain band, digitize it, and perform power estimation.

If this power is below a certain threshold, the detector decides H_0 : the band is free. Otherwise, it decides H_1 : the band is occupied. In many cases, most of the noise that arrives at the detector is from the receiver itself due to the noisy analog circuitry. The problem here is how to set this threshold. Let us use a comparable problem that we can all relate to. Suppose I throw 100 dice and tell you only the sum of all eyes. Now you have to decide whether or not one of the dice has been tampered with such that it will always show '6'. How would you do that? If they are all normal dice, the expected sum is 350, because 3.5 is the expected value for one die. But what if the sum turns out to be 353? It is not unlikely that even with normal dice I would get this number. So, if you put the threshold too low, you can generate a *false alarm*: you say some dice have been tampered with, but that is not actually true. On the other hand, if you put the threshold too high, I may have tampered with some dice, but you don't notice. This is a *missed detection*. Clearly, there is a tradeoff between the probability of false

alarm (denoted as P_{FA}) and the probability of missed detection (denoted as P_{MD}). One way you can improve your decision is to ask me to repeat the experiment 10 times. If the *average* sum would be above 353, P_{FA} is already a lot less than it was for a single experiment. Similarly, P_{MD} is also reduced. So, by averaging more often (or for DSA, measuring longer / using more samples), detection performance can be improved.

You can imagine that it will be easier to distinguish between the two hypotheses if I have tampered with more dice, since this will imply a larger distance between the expected values of the two hypotheses. Similarly, a larger signal $s[k]$ is easier to detect than a smaller signal. Therefore, the SNR, defined as $|s|^2 / |n|^2$, is a relevant parameter.

In practice, the number of samples K will be limited, because you quickly want to make a decision which band to use. This implies that for a certain maximum P_{FA} and P_{MD} , only signals above a certain SNR can be detected. Interestingly, it turns out that when you do not exactly know the noise power, but only to within a limited accuracy, a minimum SNR still exists, even when your measurement time is unlimited! This SNR is known as the *SNR-wall*, because if you

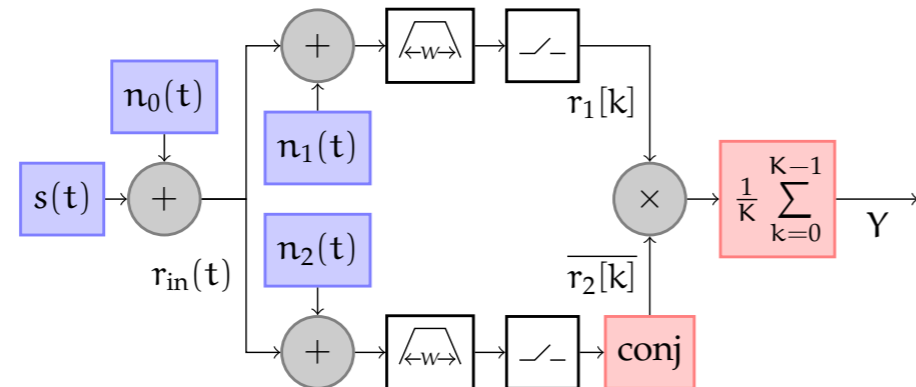

Figure 5: Principle of crosscorrelation: receive noise plus a signal (or just noise), split it to process it independently with two receivers, and combine the receiver results for the power

plot the minimum SNR on the x-axis, and the required number of samples on the y-axis, the graph seems to hit a wall: it has a vertical asymptote (as will be shown later).

Crosscorrelation

In order to mitigate these problems (and some others, which are not discussed here), I propose to use *crosscorrelation* (XC), which is a form of ED quite similar to AC as we have discussed so far. The principle is shown in fig. 5. Rather than conjugating and squaring the output of a single receiver, the outputs of the two receivers are multiplied (with one receiver output conjugated). As a result, the input signal itself undergoes exactly the same process as in fig. 4, while the noise contributions of the individual receivers are crosscorrelated and largely average out. The power estimation process I use is

$$\hat{P}_{xc} = |Y| = \left| \frac{1}{K} \sum_{k=0}^{K-1} r_1[k] \overline{r_2[k]} \right|$$

It can be shown that, theoretically, the SNR-wall of XC is lower than that of AC. The intuitive explanation is that $n_1(t)$ and $n_2(t)$ in fig. 5 are averaged out, because their product has an expected value of 0 as they are independently generated by the individual receivers. Therefore, any uncertainty in their power thus also disappears. Only $n_0(t)$ (which represents external noise and shared noise of the receivers) and its uncertainty eventually remains.

Fig. 6 shows a simulated result of the individual receiver output spectra (which cor-

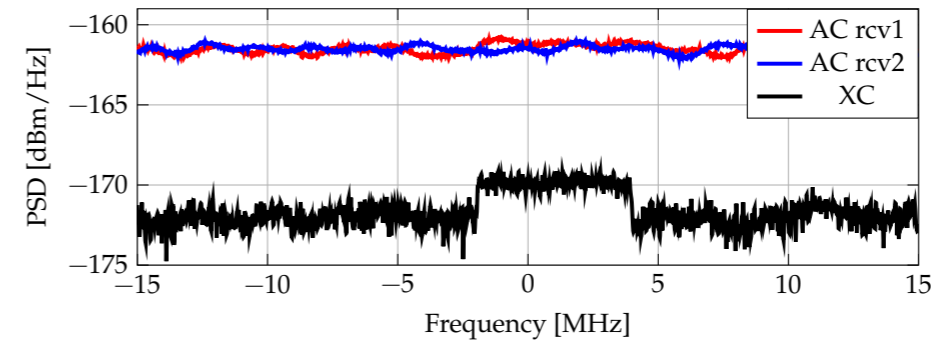

Figure 6: Visual example of the benefit of crosscorrelation with respect to autocorrelation in the presence of noise power uncertainty.

respond to AC), and the combination of the receiver outputs using XC. The noise uncertainty is modeled as a noise floor that is not perfectly flat over frequency. Our eyes can easily identify the 6MHz wide signal in the XC spectrum, but they cannot detect it in the individual receiver spectra.

Prototype

In order to verify these theoretical results, I have built a prototype in 65nm CMOS technology with two integrated RF receivers. The baseband circuitry and analog-to-digital converters (ADCs) are left off-chip, and the signal processing is performed on a PC in Matlab. The frontends can be used separately (for regular reception), or can be put in parallel via on-chip switches to enable XC spectrum sensing. The receivers can receive signals anywhere between 300MHz to 1GHz with a baseband bandwidth of about 40MHz.

By storing the outputs of both receivers and processing them offline, the power estimators and can be directly compared: the samples, and thus any temperature and gain variations (which typically are the main causes for uncertainty in the noise power), are identical.

Measurement procedure

- 1) Measure the noise floor and estimate the noise uncertainty;
- 2) Find the thresholds for desired P_{FA} of

- 10% for various K and SNR;
 - 3) Find P_{MD} for various K and SNR using the thresholds from step 2.
- The noise floor is determined by measuring the averaged output spectrum of the individual receivers without applying an input signal. The ADCs sample at 10 MS/s: the baseband frequency ranges from -5 MHz to 5 MHz. In every measurement, 1024-point FFTs with rectangular windows are used,

and only the bins that fall between 2MHz and 3MHz are used in our detection algorithms. The noise power is determined by adding the power in the 103 bins that fall within that band. Fig. 8 shows the output noise floors of 13 measurements. The last measurement was done almost two hours after the first measurement. As you can see, the noise level fluctuates over time! The difference between the highest and lowest total power is what I use as the value for the noise power uncertainty, which in these measurements is slightly more than 0.07dB.

The thresholds are determined for each of the 13 experiments, and shown in fig. 9. The noise fluctuations cause the thresholds to be slightly different for each of the measurements. The maximum of all values is used as the final threshold to "guarantee" that P_{FA} does not exceed our desired P_{FA} of 10%. Note how much lower the threshold for XC is! This is due to the fact that most of the noise is being averaged out.

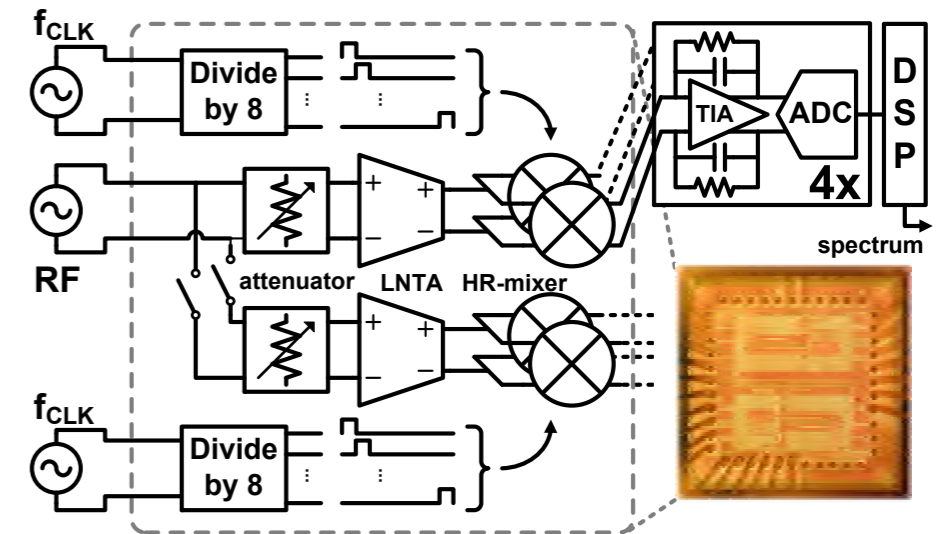

Figure 7: The system setup and chip photo (integrated parts inside dashed box)

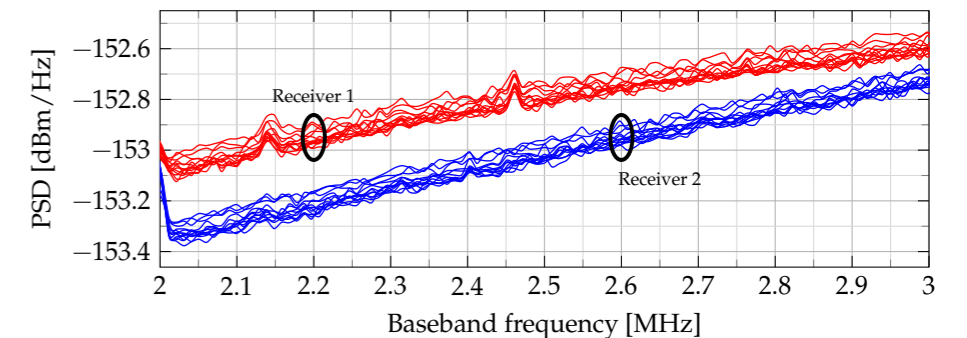

Figure 8: Noise power spectra of the individual receivers (13 measurements)

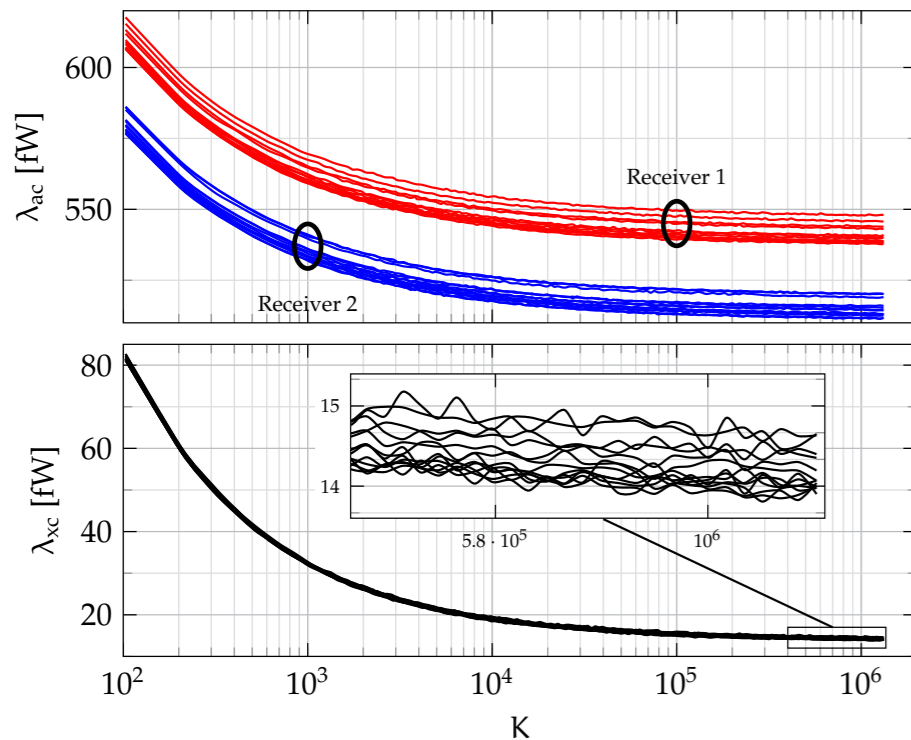

Figure 9 Obtained thresholds for autocorrelation (λ_{ac}) and crosscorrelation (λ_{xc}) for $P_{FA}=0.1$ in 13 measurements.

Finally, the input signal is applied, and the threshold values found earlier are used to determine P_{MD} for several SNRs. As input signal, I have used a noise-like OFDM signal with a bandwidth of 1MHz. To create a different SNR, I simply decrease the signal generator output. An example for high SNR is shown in fig. 10. In each measurement, 227 complex samples per receiver are captured (limited by computer memory), which results in 13.5 million independent samples available to detect the signal. To find a P_{MD} of 10% (which I used as the desired maximum value), at least 10 independent realizations are needed. This leaves maximally 1.35 million samples available per measurement.

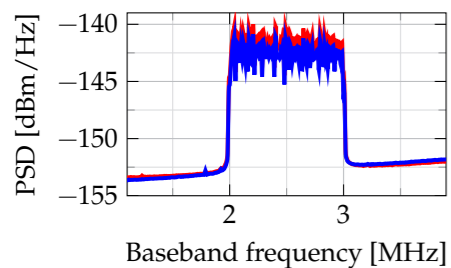

Figure 10 Output spectrum with a signal present between 2 and 3MHz at an SNR of approximately 10dB

Measurement results

By using the thresholds found before, it is relatively straightforward to find the measured P_{MD} . In fig. 11, the results are shown, where the probability of detection P_D , rather than P_{MD} , is shown ($P_D=1-P_{MD}$). As explained before, increasing K will improve detection performance, and that is what you see for the higher SNR in the left two parts of the figure. What you also see, is that the two autocorrelations of the individual receivers require higher K for the same detection performance as the XC process. This can be explained by the fact that XC uses the out-

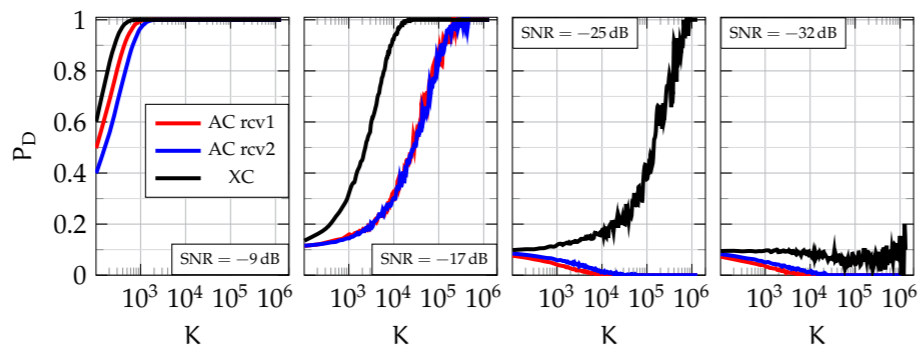

Figure 11 Measured P_D for $P_{FA}=0.1$ as a function of K for several SNRs

put of two receivers, and thus the XC-detector has more information. What is also interesting to see is that at $SNR=-25dB$, the P_D for AC goes down rather than up. This means that due to the noise power uncertainty, it is better to throw a coin to decide whether a signal is present or not, than to rely on the detector! At $SNR=-32dB$, the same happens for XC as well.

Why does this happen? Let us go back to the dice-experiment. Assume my 'normal' dice are not perfectly normal, but on average I throw somewhere between 3.4 and 3.6 per die. To be on the safe side (you don't want to generate too many false alarms), you choose 3.6 as the expected value per die. Actually, the dice turn out to be normal anyway. However, I also have one tampered die that always returns 6. The expected value for 100 dice is thus 3.6. As I throw only a few dice, there is still a reasonable chance that the value exceeds your threshold of 3.6. So, your $P_D > 0$. However, as I repeat the experiment, and you average the results, the probability that this average sum exceeds 362.4 becomes smaller and smaller, and P_D gets closer and closer to 0. This is exactly what happens in fig. 11.

With all the measurement results analyzed, I can explicitly show the SNR-wall by plotting the required number of samples for different SNR. This is shown in fig. 12. The theoretical lines (see [1] for the derivation) are also shown, and correspond very well with the measurement results. Indeed, as expected, we can detect significantly smaller signals in the presence of noise uncertainty with XC! At low SNR, it is also much faster, so it is not only better for your battery life, but also enables faster response to available spectrum holes and thus improves data throughput.

Conclusions

Dynamic spectrum access is a promising way to use the scarce spectrum more efficiently. It can do this by sensing the spectrum and identifying locally and temporally unused bands, which can then be opportunistically used. Sensing these holes is quite a challenge, especially if you do not have any knowledge of the signals you need to detect. The use of crosscorrelation spectrum sensing, which uses two receivers rather than one to process the same signal, seems to give a significant improvement in terms of detection performance over the traditional means of energy detection. In the measurements performed with a prototype, the improvement is more than 12dB. Intrigued by any of the parts discussed in this article? You can find much more information in the references. If you would like to work on this topic for a research, Bachelor or Master project, feel free to contact Eric Klumperink at the ICD-group (e.a.m.klumperink@utwente.nl)

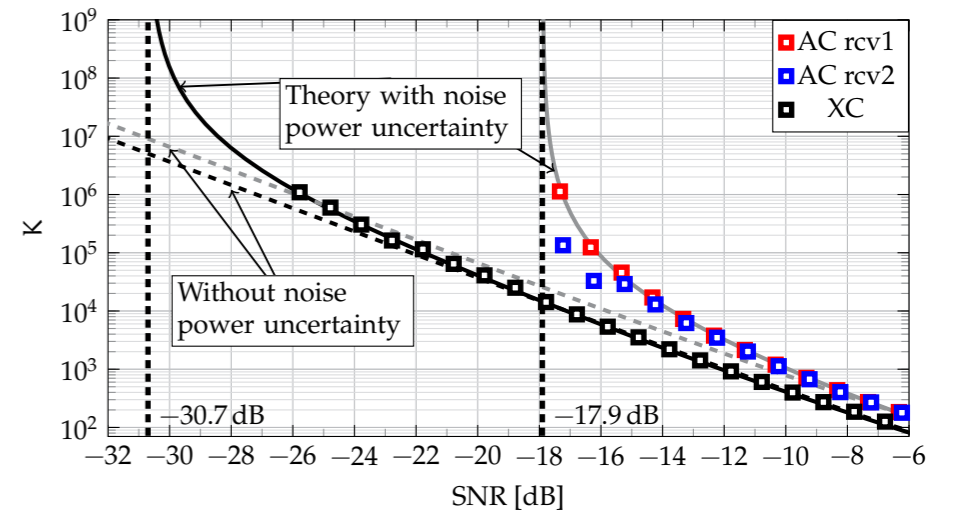

Figure 12 The SNR-wall for XC is -30.7dB in this experiment, almost 13dB better than the SNR-wall for AC.

or André Kokkeler at the CAES-group (a.b.j.kokkeler@utwente.nl).

References

- [1] M.S. Oude Alink, "RF Spectrum Sensing in CMOS Exploiting Crosscorrelation," Ph.D. dissertation, University of Twente, Enschede, May 2013.
- [2] M.S. Oude Alink, A.B.J. Kokkeler, E.A.M. Klumperink, G.J.M. Smit, and B. Nauta, "Spectrum Sensing with High Sensitivity and Interferer Robustness Using Crosscorrelation Energy Detection," IEEE J. Emerg. Sel. Topics Circuits Syst., vol. 3, no. 4, December 2013.

Technolution

>topplek
voor jouw stage

>dieptechnologisch

Waarom wachten tot je bent afgestudeerd? Ervaar al tijdens je studie het gevoel van werken in een dieptechnologische omgeving - tijdens een stage! Werken met vakgenoten waar je jouw technische kennis nu al kan inzetten. Bij Technolution krijg je die kans. Jouw werkplek staat zelfs al klaar.

www.technolution.eu/stage



Uncertified succes

Author: Maarten Segers

The previous two Afterlife articles (written by LarsZ and BramT respectively) have two mayor topics in common. They both include a period of after-graduation-travel-time (not to be confused with after-graduation-time-travel) and they both involve an actual graduation to start this period off with. Although my story has plenty of travel in it, it really lacks in graduation. Because of this graduation deficiency, the story has no obvious point to start at, so I'll just start at the beginning.

It was 2005 when I first set foot on the hallowed grounds that form the University of Twente. I had gotten through high school without much trouble and I figured Electrical Engineering would fare me equally well. It did not...

6 years passed and although at this point the first EE students of my year started to graduate, I was nowhere near graduation myself. I had spent most of my time on drinking beer, traveling and sleeping and I only managed to pass the easy, the fun and the interesting courses leaving me the hard and the boring ones. I decided, as so many times before, that the coming year would be the year I finally got of my lazy ass and started making an effort. It wasn't...

I ONLY PASSED THE EASY, THE FUN AND INTERESTING COURSES

Shortly after the start of the new semester I decided to join the study tour committee and go on one last study tour. Looking back on it now it is easy to see, but it took me quite some time to realise I was just avoiding the real issues and that I was unlikely to graduate any time soon, if at all. The amount of time invested demanded some kind of pay out, but investing more time was not the answer. I had to come up with an alternative. I had to abort!

Contrary to my roommates advice I had no exit strategy, I had to come up with one before the end of the semester. I usually got pretty decent grades for practical assignments and projects and I had some experience with hobby-level electronics design, so I figured I could probably get a low level job in an electrical engineering company somewhere and slowly work my way up the corporate ladder. I decided to stay in Enschede as it has a good concentration of suitable companies nearby and if I kept my (cheap) room I required a lower wage to have a decent income. Both things increasing my chances of finding something fast. Several months passed without much progress. It seemed I applied the same work

ethics to finding a job as I did to my education. I did do some searches on job websites and I was satisfied with the overall abundance of jobs that I was sure I would find something in due time. Some more time passed and out of the blue I got a forwarded email from a friend. I had helped her with her bachelor assignment which included some LED lighting and control electronics. I assisted her with the electronics design and I soldered the whole thing for her.



The email she forwarded was from LED-consultancy, the Amsterdam based LED lighting company she did the assignment for and it stated that they had seen my work and liked it and they asked if I might be interested in a job. I was! So I contacted them and a few days later I took a train to Amsterdam and had an informal conversation on what we could do for each other. We agreed that I would work there for a couple of days, just to test the waters, and that we would see where we would go from there.

Then D-day was finally there, the first of September, the first day of civilian life. But instead of running to the nearest welfare office, as one might expect, I went to the bank to collect large quantities of Chinese currency. There was still a study tour that had to take place and there were only a few days left until it started. Those last few days went by in a flash and that Friday we left for Beijing. The three weeks that followed were filled with pretty standard study tour stuff. Visiting amazing companies, doing all sorts of fantastic cultural activities, eating delicious food and doing loads and loads of partying! For a full report on the study tour I would like to direct you to 'de Vonk' from the beginning of this year, but trust me, it was pretty awesome. All in all a fitting end to my life as a student and a nice start of my life as a civilian. But wait there's more!

As is usual with study tours I decided to attach a little vacation to the end of it. As I was already in Asia I saved the cost of air

travel, leaving more room in my budget for other things. The study tour ended in Hong Kong from which I boarded a plane heading to the Malaysian part of Borneo. I did not do much preparation for this trip and I pretty much only booked my plane tickets and would sort out the rest on location.

I spent the two weeks that followed mountain climbing, jungle tracking, boat riding, hiking, driving my motorbike across the country and sitting on the beach doing nothing and relaxing. I then boarded a plane to India. Again I was totally unprepared and I only knew that I would land in Chennai and that I would have to leave three weeks later from New Delhi (several thousand kilometres away). The time in between I spent doing pretty much the same things I did on Borneo all while slowly making my way to New Delhi on busses, boats, planes and the wold famous Indian railway system.

By the time I got back to the Netherlands I had been away for two months. In that time my job finding quest had not progressed at all. It was time to get that all back on track. I got back in contact with LED-consultancy and went in for a job interview. By that time the company had grown from 2 to 4 employees. One of the new employees being a senior electronics designer to whom I



I started on my first LED driver designs. We moved to another building after my first week and we had gotten a pretty decent budget to furnish the new electronics lab, this meant I also got to spend some time shopping around for new equipment. As my designs progressed more and more safety and normalisation issues arose so I took a couple of weeks to dive into to these issues and read up on European norms and regulations concerning LED lighting and electronics in general.

Watt). My designs kept evolving as well and I wrote and filed a patent on one of them. The electronics design team got expanded with a support technician and we recently welcomed the newest member to our team and the 15th employee of LED consultancy. None other than DenickM, who most of you know, was hired as an electronics designer/IT manager.

We are now on our way to finalize our first real products and we hope to release them on a big lighting fair in March. No one knows what the future will bring for this company and what my role in it will be. The main advantage of smaller companies is that you have more room to grow and you don't follow a set career path. Jobs are not clearly defined and you might be expected to do all sorts of things (or maybe even all of them!). This gives you the chance to diversify and maybe find something you really like.

In Christian folklore the afterlife is where souls go after the deaths of the mortal bodies that once housed them. Applying this to student life could sketch the following depressing picture: At the moment of graduation (or at any other study terminating event) the student soul goes to heaven leaving the soulless body to roam the earth as a corporate zombie for what seems like an eternity. Yikes!

Don't worry, the real afterlife is not that bad. It pretty bad, but not that bad! And then of course there is the money, the sweet, sweet money...!

Reference:
http://en.wikipedia.org/wiki/List_of_college_dropout_billionaires

I WAS THE ONLY ELECTRICAL ENGINEER IN THE COMPANY

would be a junior. I got hired and we agreed that I would start 2 months later, giving me time to get my driver's license and find a place to live in Amsterdam.

On the 15th of February I finally started my job and after a few weeks of orientation

In the meantime the company kept on growing, by that time we were up to about 10 employees. The electronics department still consisted of only my senior and me, but that was about to change. Not that we grew. On the contrary, my senior got fired! The main reasons for this were his passive attitude and his general incompetence. Not that I would really miss him, but from this time on I was the only electrical engineer in the company and I was therefore also the only one responsible for all electronics related affairs.

Months went by and the company kept evolving. It now had two new companies in the same holding. One for measuring all relevant parameters of LED lighting (lumen output, spectrum, emission pattern, etc.) and a one for packaging LED dies into high power LED modules (10 to 500



Birthday cake

Thales Nederland

Een interview met Tom Griffioen en Hugo Anbeek

Beiden werken bij Thales Nederland te Hengelo. Tom heeft elektrotechniek gestudeerd aan de Universiteit Twente en Hugo heeft technische natuurkunde aan de Universiteit Twente gestudeerd. Ze werken nu allebei ongeveer 4 jaar bij Thales en vertellen over hun dagelijkse werkzaamheden en andere ervaringen als Young Professional binnen Thales.

Wat doe je nu bij Thales?

Hugo: "In mijn dagelijkse werk houd ik mij bezig met het bepalen en analyseren van operationele radar performance. Met behulp van complexe modellen simuleren we wat de detectie-afstand van onze radarsystemen is tegen verschillende doelen (dreigingen)- onder verschillende atmosferische omstandigheden. Bij het ontwikkelen van modellen, het simuleren en analyseren van simulatieresultaten maak ik elke dag opnieuw gebruik van de kennis die ik tijdens mijn studie heb opgedaan."

Tom: "Als system engineer is het belangrijk systeem performance en subsysteem performance op elkaar af te stemmen. Neem bijvoorbeeld een verzonden signaal. Een radar zendt, net als sonar, een signaal uit dat reflecteert op het doel en weer terug valt op de radar. Zonder verder diep op de details in te gaan heeft de kwaliteit van dit signaal (gegenereerd door de signaal generator op subsysteem niveau) invloed op de performance van de radar (systeem niveau)."

Wat gebruik je nog van je studie?

Hugo: "Netwerktheorie tot en met signaaltheorie en veel wiskunde. Dit kan je allemaal toepassen op de techniek. Bij Thales kan je terecht met veel verschillende disciplines, van werktuigbouwkunde tot elektrotechniek tot IT."

Tom: "Het leuke is dat ik zeker nog 50% gebruik van wat ik heb geleerd tijdens mijn

studie. Je werkt hier aan complexe systemen en de optimalisatie gaat heel ver. Elke beslissing die je neemt kan verregaande gevolgen hebben voor het systeem."

Hugo: "Het is echt High Tech, je moet op de hoogte blijven van de laatste stand van zaken omtrent de nieuwste technologische ontwikkelingen en de wetenschap."

Tom: "Als voorbeeld heb je een radar die je nu ontwikkelt en pas over 7 jaar aflevert; in die 7 jaar gebeurt er heel veel in de techniek. Ook al maak je de radar daarna opnieuw, dan heb je te maken met nieuwe technieken en nieuwe mogelijkheden."

Hugo: "We werken nauw samen met de TU's, maar we ontwikkelen hier zelf veel nieuwe technologieën, verder doen we research waardoor de TU ook weer van onze kennis gebruik kan maken."

Waarom heb je voor Thales gekozen?

Tom: "Mijn vader werkte bij Defensie als bouwkundig architect. Ik ging een keer mee naar de Marinedagen en het enige wat ik zag was een ronddraaiende radar. Jammer dat de Phased-Array radars (Red: op alle vier de zijden zitten radarantennes, zodat het systeem niet meer rond hoeft te draaien) niet meer draaien. Nu werk ik aan de SMART-L EWC (Red: lange afstand radar tegen ballistische raketten, zie foto Tom en Hugo), die draait weer wel."

Hugo: "Mijn vader werkte vroeger bij Thales dus ik kende het bedrijf en de verhalen.

Tom Griffioen (links) en Hugo Anbeek (rechts)



Hiervoor heb ik bij de NAVO gewerkt. Ik was dus al bekend met de Defensiewereld en die wereld vond ik heel interessant."

Wat is dan interessant?

Hugo: "De diversiteit in projecten. Je doet bij Thales geen alledaagse dingen, je werkt aan High Tech systemen. Dat geeft een enorme kick."

Tom: "Je opereert echt op wereldniveau en het is 'grote jongens speelgoed'."

Hoe ziet een gemiddelde werkdag eruit?

Tom: "Heel verschillend. De ene dag werk je aan een project en moet je heel veel overleggen om te kijken wat we willen en kunnen, terwijl ik de andere dag de hele dag aan het simuleren en modelleren ben."

Hugo: "Nee je werkt nooit aan één project tegelijk. Soms werk je aan iets intern terwijl je de volgende keer met de klant zit en vragen moet stellen als; wat heb je nodig? Wat past bij jullie? Met welke dreiging hebben jullie te maken? Hier moet je dan weer analyses op loslaten en engineers opzetten."

Aan wat voor projecten werken jullie nu?

Hugo: "Nu werk ik aan een paper voor een conferentie, dit doen we in nauwe samenwerking met TNO en daarnaast ook aan de gatekeeper en de goalkeeper."

Tom: "SMART-L en het STARS project <http://starsproject.nl/>."

Hoe zou je de cultuur bij Thales omschrijven?

Hugo: "Je hebt heel veel verschillende mensen die hier werken en het verschilt per afdeling. Daarnaast is het gemiddelde werk niveau heel hoog. Bijna alleen HBO en WO en dit is een leuke mix."

Tom: "Er is een hoge gemiddelde leeftijd, maar van deze oudere mensen kan je als jong persoon heel veel leren. Dit bedrijf is juist dankzij de jarenlange ervaring en kennis wereldleider geworden op het gebied van marine radarsystemen. Over het algemeen is er ruimte genoeg om je eigen ideeën in te brengen."

Hugo: "In het begin moest ik even schakelen. Ik was jong en ambitieus en nam een sprint. Ik werd wel even afgeremd, maar dat kan niet anders. Bij Thales heb je één á twee jaar nodig om de wereld en de techniek erachter te begrijpen. Je hebt bepaalde ervaring en kennis nodig voordat ze je naar de klant laten gaan. Het is niet een alledaags product dat als je het niet aan de één kan verkopen, je naar de buurman kan gaan.

Deze wereld is delicaat en potentiële klanten kan en mag je niet kwijtraken."

Tom: "Wat verder leuk is dat als je hier werkt, je langzaamaan ook doorkrijgt dat je projecten/opdrachten naar je toe kunt trekken. Zo kan je je door de organisatie heen manoeuvreren. Je moet hier proactief zijn, anders wordt het niets."

Waar ben je trots op?

Tom: "Ons hele productportfolio. Als je bijvoorbeeld naar een land in Zuid-Amerika gaat hebben ze onze sensoren op hun schepen staan. Onze aanwezigheid in de wereld is gigantisch."

Hugo: "Daarnaast moeten we altijd opnieuw op technisch vlak blijven innoveren ten opzichte van de concurrent. Dat houdt je scherp."

Tom: "De complexiteit van de systemen en het proces. Je werkt met gemak met 100 mensen aan één project. Dat moet ook gecoördineerd worden. Zelfs universiteiten vragen ons wat we nodig hebben qua techniek en vragen ons om nieuwe technieken. Dat zie ik als een goede referentie en als uitdaging."

Heb je nog laatste toevoegingen?

Tom: "Ja, je kan hier je hele leven blijven werken. Mijn vrouw denkt dan; 'saai zeg', maar er is hier zoveel te doen. Het is niet saai, het is gewoon echt interessant en divers werk. Wil je meer met mensen werken? Wil je meer alleen werken? Bespreek het en het behoort tot de mogelijkheden. Ik vind het wel jammer dat de man/ vrouwverhouding binnen Thales scheef is. Het lijkt me leuk als er meer vrouwen zouden werken."

Hugo: "In het begin is het wel lastig en moet je even wennen, je moet jezelf de tijd gunnen om alles te leren en je de systemen eigen te maken maar na twee jaar ben je echt op stoom."

Tom: "Ja, dat merk je en je ziet ook dat de mensen die hier werken echt gepassioneerd zijn voor het vak. Dat kan ook niet anders, maar iedereen gaat er voor de volle 100% voor. Ik hoorde van de 34 WO-ers die hier de afgelopen drie jaar zijn aangenomen, er in totaal maar drie zijn weg gegaan."

**Innovative Solutions
START WITH THALES**

Op het gebied van veiligheid is Thales één van de meest innovatieve bedrijven ter wereld. We bieden alle krijgsmachtonderdelen en civiele hulpdiensten de middelen om hun taken optimaal te kunnen uitvoeren. Onze producten kunnen overal ter wereld worden ingezet op vrijwel ieder type platform: ter land, ter zee en in de lucht.

www.thalesgroup.com/nl

THALES
Smarter. Safer.



General meeting



Film evenings



Introduction



Tapfactor borrel



Bobby on wheels

Author: Tim Broenink



For my bachelor assignment I was doing an assignment at RaM. For this assignment I had to create a software implementation to control a robotic base. This base had to determine its position in an environment and map the environment itself. But before I tell you anything on how I did my assignment and the results I got, I will tell you a bit about the localization and mapping problem in general, why it is important and how it works. After this I will explain more about what I have done in my assignment and the results I have gotten.

The task that the software had to accomplish was to simultaneously map the environment it was in and determine its position in the same environment. This is done to answer two questions that are quite natural for us humans: "What does the world look like?" and "Where am I?". These questions appear simple for us, but we must not forget that we humans use a complicated system based on 3-dimensional vision, object recognition, pattern recognition and a whole lot of computational power to accomplish this task. This is not easy to do on a robot with limited sensor capabilities and a limited amount of processing power. This is why it is often simplified on robots by for example using only depth information or working in 2 dimension. This can reduce the load on the system.

Regardless of the exact implementation chosen a simultaneous localization and mapping (SLAM) algorithm boils down to a few steps:

- Measure the environment
- Modify the environment, by moving the base
- Measure the environment again
- Modify the world belief based on the measurement
- Repeat.

Of these steps most are self-explanatory. The measuring is done with the sensors the robot has on board and the moving is usually a simple task. The modification of the world belief is probably best explained

with Figure 1. Let us assume we have a simple robot that can drive with a bit of error and that can detect "Landmarks" in a certain area. This robot can be placed in an environment with some of these landmarks. In can then detect the position of the set of "Landmarks" that are in range (1.A). Now the robot knows how its environment looks. After this the robot can modify its environment by driving forward, but due to some error or other effect the robot does not drive perfectly safe. So the belief of the robot of its position (1.B) does not coincide with the robots actual position. So as

the robot thinks itself to be in another position then is the case, the robots belief of the world around it as measured in 1.A will not be the same as what the robot measures (1.C). The robot can now use the difference in the measurement and his belief to update its belief of the environment. As we can assume that the robot is more prone to driving a bit wrongly then the environment is to change suddenly, the robot can deduce that its belief of its own position is wrong and update it accordingly. Now the whole cycle can start over again.

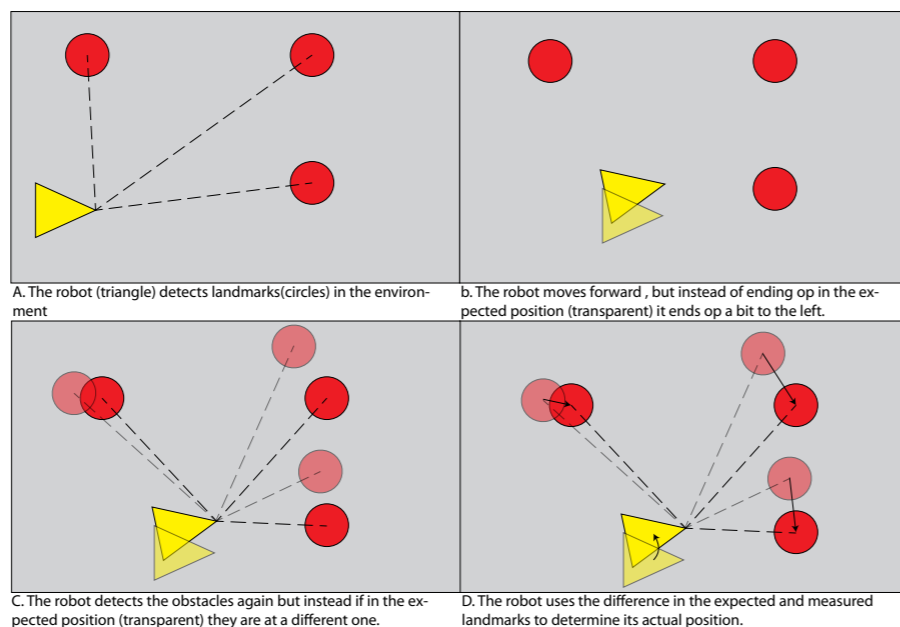

Figure 1: The basic SLAM algorithm can be repeated endlessly while detecting new landmarks



Figure 2: The RMP50-omni platform fitted with the Microsoft Kinect and the appropriate power supply and connections

with a certain set of sensors and a certain robot base. As you can probably imagine, this had a large effect on the eventual implementation. As a sensor, I used a Microsoft Kinect, which has a range of 0.7 to 6 meters and a field of vision of 57° horizontally and 43° vertically. The Kinect provides a RGB output stream providing color information and a depth output stream. With this, a three-dimensional color representation of the environment could be theoretically built. For the base of the robot a RMP50-omni from Segway was available. This is a platform made by putting two of the platforms together that are used to make Segways and by providing the system with mecanum wheels. This platform can thus drive holonomically, or better said, it can drive forwards and backwards, rotate left and right and move left and right. The combination can be seen in figure 2. While developing the system, I used a simple laptop connected to the platform, but later on a specialized computer was ordered. For the hardware enthusiasts I have put the specifications of the computer in a separate table.

THE KINECT PROVIDES A RGB OUTPUT STREAM PROVIDING COLOR INFORMATION AND A DEPTH OUTPUT STREAM

The specialized computer used for the system in the end. Notice the scale from the usb-ports on the front.



The computer hardware:

| | |
|--------------|--|
| Motherboard: | AOpen DE67-HAI, i5/7 3rd Gen |
| Processor | Mobile i7-3720QM s988A 3.6GHz 6MB 45W TRAY |
| RAM: | 8GB CL9 1333MHz |
| Storage: | Intel SSD 330 series 60GB |

This example was a very simple example of a slam algorithm and it can be greatly improved with different techniques. Possibilities for this include the utilization of a statistical model to not keep with one world belief,

but to make an probability map of how the world could look. This would keep previous measurements into account and can be combined with an probabilistic model of the driving action of the robot and the functioning of the sensor. Other ways that previous measurements can be implemented is by keeping a record of all of them and letting new information change this whole tree of measurements and position estimation. Both these methods require a lot more processing power but both are more reliable if one would use imperfect sensors or is operating in a changing environment.

Hardware

For my bachelor assignment I had to work

Software

My actual assignment was to create a software package to control the robotic base, based on the Kinect sensor input. The goal was to make the robot drive around autonomously while mapping its environment, determining its position and evading obstacles. The software had to work with the Robot operating system (ROS). The fact that ROS is designed to be extremely modular worked in my favor here, as I could easily split up the system into the following modules with their own respective task. First up was the vision module. This module was made to acquire the data from the Kinect and to process that data to a useable form. To prevent the system from taking up

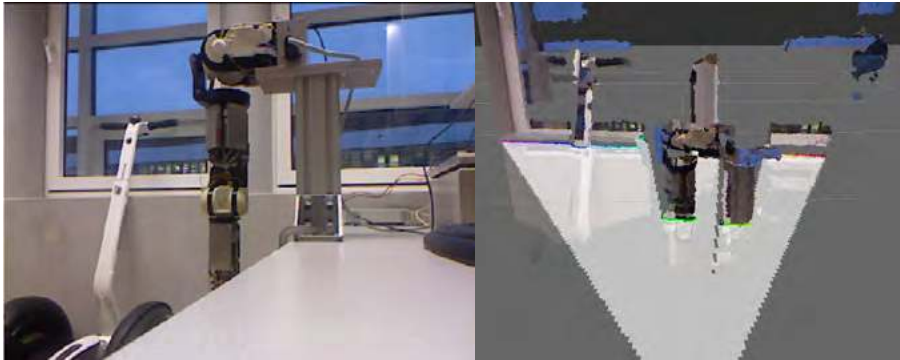

Figure 3: The vision module turns the setting on the left into the data on the right, creating a point cloud and a 2D scan

to many recourses, the data is reduced to a two-dimensional distance map by selecting a three-dimensional region of a certain height and determining the closest point. This allows the rest of the processing to occur in a 2D form. This effect can be seen in figure 3.

all the measurements and can correct previous measurements if new data is received. It implements two other mapping algorithms, one to find its location in a premade map and one to create a 3D map based on other position sources. The effects of the GMapping algorithm are clearly visible if one

THE MOST IMPORTANT MODULE IS THE NAVIGATION STACK

The second part of the system was the mapping module. This module can implement a set of different mapping algorithms. The first one and the most basic is GMapping, which is a complete SLAM algorithm that can create a map of the environment and determine positional errors. The nice thing about this algorithm is that it creates a list of

turns it on and then move the Kinect a bit, it will quickly see the difference and update the position, as can be seen in figure 4

The Next and most important module is the navigation stack. The navigation stack employs a diversity of techniques to navigate the robot. First off, it will use the maps

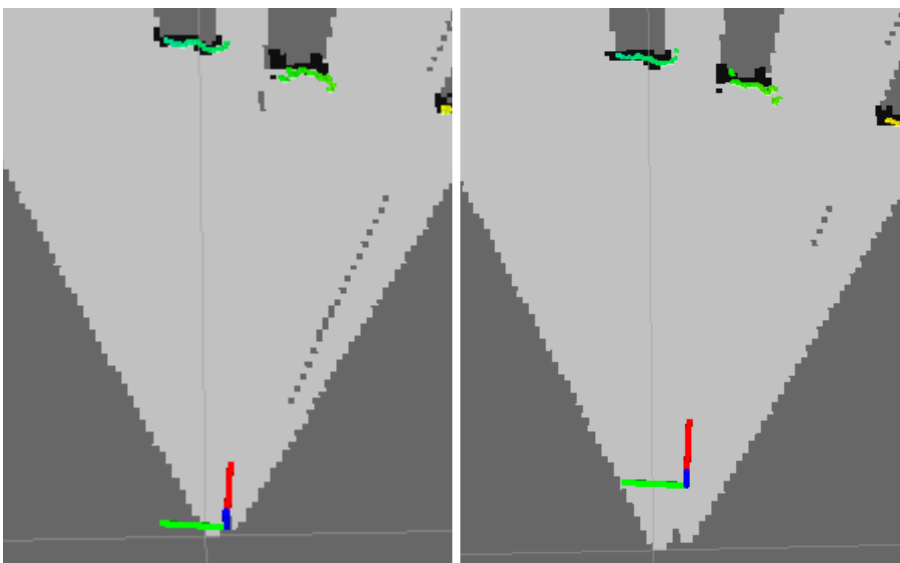

Figure 4: The effect of moving the kinect sensor. The axis is quickly updated to the new position

provided by the mapping module to create a global costmap. This map is used to plan the global route of the robot. This route can then be passed to the local navigator. The local navigator keeps a local map of all the obstacles that are detected with the Kinect and uses this local map to plan the local route of the system. Here it takes care to avoid any obstacles as good as possible. The local planner then passes this route to the motion planner, which takes into account the current speed and heading of the base and uses this information to determine what move commands to send to the robotic base. These three parts combined make it possible for the robot to plan a route to any point on the map and to drive to it while avoiding obstacles, even the ones that aren't on the map.

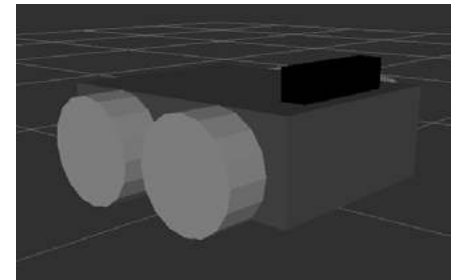

Figure 5: A graphical model of the robot

The last module in the system actually sends the movement commands to the base to move it. This module also reads in the sensors in the base to determine the current position based on the movements of the base and a physical model of the robot. This positional change will then change the environment of the robot and we can start at the vision again, to measure the environment, detect obstacles and update our map and to change our route based on our new world belief.

The full slam chain is now complete and the robot can drive around trying to avoid obstacles. The system is however far from complete. It still has problems with object that get too close due to the fact that the Kinect has a minimum range. However due to the modularity of ROS the sensors could be easily swapped out or supplemented with other sensors. This makes it easy for future work to improve on my design.

Scintillas thin client

How SOT does it

Author: Koen Zandberg

The Scintillakamer is filled with computer equipment. One of the most notable things among this equipment are the thin clients. These occupy most of the space on the desks and are frequently used by the active members. But it appears that most of the members don't have a clue what they are.

What is a thin client?

Wikipedia describes a thin client as the following: "A thin client (sometimes also called a lean or slim client) is a computer or a computer program which depends heavily on some other computer (its server) to fulfill its computational roles. This is different from the traditional fat client, which is a computer designed to take on these roles by itself. The specific roles assumed by the server may vary, from providing data persistence (for example, for diskless nodes) to actual information processing on the client's behalf."

This definition applies to the thin clients in the Scintillakamer. When a thin client is started, it boots a linux installation provided by one of our servers, Alexia. Since a thin client doesn't have any storage, anything they need has to be provided over the network. When fully booted the users are presented with a graphical environment with a small menu. A thin client doesn't have much computational power, so most of the time the users connect with Winscin, our windows remote desktop server to do their work.

This setup has a few positive consequences for users as well as for the SOT. A long time

back, the Scintillakamer had twelve workstations. If a piece of software needed to be installed or updated, a SOT member had to go to every workstation, perform the task and move to the next. A menial task and not very motivating to do. Nowadays most users use Winscin to work on instead of the thin client. This way the software is installed on a central server. If it needs to be updated, it only has to be updated on a single place. Furthermore, it doesn't really matter what happens to the thin client. It can crash, shutdown or disconnect. Since the actual work is done on Winscin, nothing would



The benefits for the SOT are mostly that everything is managed from one central location. If something needs to be changed or installed, we only have to install it on the Linux installation or on Winscin.

The hardware

Although it is technically possible to make a thin client out of any combination of computer hardware, the hardware of the current thin clients used in the Scintillakamer are specifically chosen to function as

THE BOOT SEQUENCE IS WHERE MOST OF THE MAGIC HAPPENS

be lost. A daily example of this is that a user can start working on one thin client, but halfway his work he can switch to another thin client and continue working. He just has to connect to his session on Winscin again. He could even start working somewhere else, for example at home. As long as he can connect to Winscin he can continue working in exactly the same environment.

thin client. It are lightweight VIA embedded boards. They feature an 1.5GHz X86 processor, an integrated video chip and half a gigabyte of ram. The processor has a feature called VIA Padlock, an additional instruction set for encryption functions. With this encryption related tasks can be sped up. The two thin clients outfitted with a 24 inch screen are a bit faster, with a 64

bit processor and a gigabyte of ram. This is indeed not very powerful, but it is enough for the functionality needed. One of the advantages is that the thin clients don't eat as much power as a normal computer, a small power brick is enough to power them. As example that any normal hardware could be used: our room in Citadel was once outfitted with two clients build out of normal desktop hardware because we lacked VIA boards for these clients.

Starting up

The boot sequence of the thin clients is important since this is where most of the magic happens. It consists of multiple stages, each a bit more complicated and capable of more than the previous stage. This is mostly hidden from the users since the thin clients are already turned on and fully booted when the Scintillakamer is open. Around five to nine in the morning all thin clients are booted by a wake on LAN packet. This initial signal boots up the thin

client. The first boot device of a thin client is the network card. This means that the network card becomes active. A so called Pre eXecution Environment (PXE) is started. Here the network device is configured by DHCP, requesting any information it

IT IS INVESTIGATED WHETHER IT IS POSSIBLE TO GIVE THE THIN CLIENTS EEPROM STORAGE

needs for a functional network connection from a central DHCP-server of the university. From this server the network card receives a server address where to receive more information from. At Scintilla this is one of our virtual machines on Alexia, netboot-alexia. The thin client then sends a request to netboot-alexia. This server returns a so called PXELINUX image. This is the menu where a user can select what he wants

to boot. Most of the time this is the default thin client image. This selection is then returned to the server which then transfers (TFTP) a Linux kernel and initial ram disk to the thin client.

These two pieces of data are copied to the memory of the thin client. The kernel is the basis of the operating system, needed for a functional system. The first thing that happens is loading the kernel. The kernel initializes the hardware of a thin client and then boots the initramfs. The main task of an initramfs is to prepare anything needed to access the final file system of the thin client. This means that it has to set up a con-

nection to the server which stores this file system. When it is done the kernel switches to the actual filesystem to further boot the thin client.

The connection to the file system is an insecure connection via the NFS (Network File System) protocol. Because this connection should be secure, an IPsec connection with the server is first made. This IPsec connection forms a tunnel through which other packets can be send encrypted. With this tunnel in place, the file system can be transported in a secure matter over the network. For IPsec a form of authentication is needed. This to provide the other party with the insurance that it is really that one client it is talking to. But what would we use as an identity. A thin client doesn't have any storage to store a pre-shared key. We could embed it in the initial ram disk, but the initial ram disk is transferred without any encryption so that also exposes the key. In the end we chose a combination of hardware dependant IDs for this key. Currently it is investigated whether it is possible to give all thin clients a small EEPROM storage and store a private key in it.

The thin client

The thin clients share their file system with each other. This means that a single thin client can't change anything on this file system because it would then change for all



The inside of a thin client

are updated. Furthermore, when somebody accidentally or maliciously changes something to a thin client everything should be back to normal when it is rebooted.

A fully booted thin client presents the user with a lightweight graphical desktop environment. To keep things simple, a user friendly tool was needed. This to give users the option to start programs, but without any explanation needed. When the thin clients were initially introduced, a program was created for this called Thintool. Thin-

beginning, thintool featured four big buttons. The core functionality has remained the same although it has been rewritten once and extended with some functionality over the time.

Besides the programs visible in this menu a thin client has a few more programs installed. Most of the additional programs are hidden. Among these programs is a simple mahjongg game and a multiplayer Pacman variant.

A while back it was noticed that some users pressed the ON-button of a thin client when the only problem was that the screen was turned off to save power. The standard behavior of the thin client was to turn itself off again after the ON-button was pressed. To counter this problem, the thin client are nowadays configured to turn their screen on when the ON-button is pressed. Only when pressing this button twice it will shut down.

With these thin clients, the Scintillakamer is easily provided with the workspace needed by members. Even after all these years of service they remain functional and powerful enough to provide anything needed. En when the work load increases we can simply add a few more of the same. In the end, maintenance and usability have never been better.

IPsec

IPsec is a collection of protocols to secure network communications at IP level. This means that any information above the IP layer is encrypted. Thus somebody sniffing packets encrypted by IPsec can only see which hosts are communicating, but not which protocol they are using. IPsec includes protocols for authentication (knowing that it is the right person you're talking to) and encryption. IPsec can encrypt data between two hosts, but also between a host and a complete network or even between two networks. The most notable advantage of IPsec is that it is possible to encrypt traffic between two hosts without the need to integrate encryption into a specific higher layer protocol.

IPsec uses a few protocols to operate:

Authentication Header (AH), a protocol providing integrity and data origin authentication. AH protects the IP header of a packet by building a hash value out of all immutable values of the IP header. Thus if a packet is changed it can be detected because the hash value is invalid.

Encapsulating Security Payloads (ESP): providing confidentiality, data-origin authentication and integrity. ESP is almost the same as AH, but in tunnel mode it encrypts the entire IP packet, encapsulating it with a new packet header. This way the entire packet is protected, while the outer IP packet is unprotected.

Security Associations (SA): an SA provides a bundle of algorithms and data providing the parameters necessary for AH and/or ESP. A SA is established by using the Internet Security Association and Key Management Protocol (ISAKMP). ISAKMP provides a few methods of authentication, for example a pre-shared secret or public-private key pairs. A SA provides a flow in one particular direction, therefor an IPsec connection usually consists of a pair of SA's.

IPsec contains two modes of operation. A tunnel mode and a transport mode. In transport mode only the payload of the IP packet is encrypted. The IP data is secured by Authentication Header. In tunnel mode the entire IP packet is encrypted. This is then encapsulated into a new IP packet with new headers. This mode is used to set up VPN (Virtual Private Network) connections, a connection with multiple hosts on at least one side of the connection.

Most IPsec implementations contain additional features, for example dead-peer-detection, a protocol extension to detect lost connections and methods to reestablish these connections.

USERS PRESSED THE ON-BUTTON, WHEN THE ONLY PROBLEM WAS THAT THE SCREEN WAS TURNED OFF

thin clients. The file system of the thin client is a read only file system. This to prevent the thin client from writing anything. Anything a thin client needs to write is written to its local memory. Any changes made are thus lost when the thin client is shut down. This setup has a few advantages, including that when a change is needed we only have to change it in one place and all thin clients

tool provides users with a really simple interface to start a few programs. Thintool is a small program used to launch other programs. Thintool provides access to Winscin, but not everybody wants to connect with Winscin. Some users might want to use a different server or simply want to browse a few internet pages. Thintool provides the buttons and thus a way to do this. From the

Master Kick-In

This year for the first time the Master Kick-In was organised by master students for master students. It all started with the idea that we could do it better than the last years. If our vision came true, you can decide by yourself after reading our impressions of the master Kick-In 2013.

Relaxing Monday

On Monday the master students were picked up at Schiphol by the people of ESN and they helped the new students with starting their life in the Netherlands. On Monday we were busy with flying back from holidays, sleeping and mentally preparing for the coming days.

Party Tuesday

The Tuesday started very early at 8 o'clock with turning the Educafé upside down. We needed to make the Educafé ready for a whole day of listening to presentations.



We picked up the 70 EEMCS master students at the Acasa tent and guided them across the campus to the Educafé where they had to sign in for the faculty Kick-In and get some coffee to wake up for the insightful presentations. There were many presentations amongst which an acculturation presentation which provided the foreign students with helpful information about the Dutch people. For example the fact that we are very blunt and direct.

After sitting still for half of the day we organised a game for the afternoon, a scavenger hunt. The master students were sent out all across the campus to solve the questions and provide evidence of it. Fulfilling more than one question in one picture would grant them bonus points. After making a slow start all groups started to answer the questions fanatically and with a lot of fun.

THE MASTER STUDENTS WERE SENT OUT ALL ACROSS THE CAMPUS

The most challenging answered questions were:

- French kiss a stranger
- Give a lecture to a professor
- Propose to a stranger

While everybody was eating their pizza and drinking free beer all points were counted. Three of the four groups finished with al-

Authors: Ilka Dove, Martijn Brethouwer

The picture that won the scavenger hunt was a picture that answered the following questions:

- Find a fish
- Catch a fish
- Find some people gangnam-styling
- Cycle backwards
- Find people with dialog shirts
- Get a cup of coffee
- Practice a traditional "stoelendans"
- Find a pair of wooden shoes
- The whole team doing the Macarena dance together in a public place

most the same amount of points. Only one group with an awesome picture with 9 answered questions won the hunt. After awarding the first team with a prize we took a large portion of the master students to the city of Enschede. We started the "stapavond" at the Beiaard drinking some special beers, after which we went dancing at the Zozo and Aspen Valley.



Kloot Wednesday

At Wednesday morning the students got a short tour through Carré and surrounding buildings, and they met their program mentors to get study specific information and ask questions. The lunch was organised by the EEMCS staff for all new EEMCS students. With the exception of an exploding gas tank the lunch was a success.

After the lunch it was time to get up off our butts. It was time to play a famous old Dutch game, "klootschieten". We started our quest with a cart loaded with beer, soda and wine to motivate the players. The group was split into four teams and we started the game behind the Horst along the road to the Cubicus. The goal of the game was to reach the barrier at the parking lot of the Cubicus with the least amount of throws of the "kloot". When the game was finished we left to the information boulevard in the

Volkspark. There all students got info about all kinds of associations. When the information boulevard closed we tried to participate in the discover Enschede game but we got hungry, so we decided to get dinner.

The Wednesday finished with the open air concert on the "Oude Markt". We enjoyed the music with a group of students and

some six packs with beer. The die-hard's ended the evening in the karaoke bar the Wigwam.



Dirty Thursday

On Thursday morning everybody could sleep in and get a nice brunch. When our bellies were filled some people of the group went to the different sport workshops and the majority went to the rush at the Bastille. After queuing for a long time we finally star-

THE DIE-HARDS ENDED THE EVENING IN THE KARAOKE BAR 'THE WIGWAM'

ted our rush. The rush was exhausting and it was muddier than expected but everybody really enjoyed it and got very dirty. After some refreshing time we met at the Grolsch veste for dinner. We were not lucky and had to queue again to get our dinner.

Just as every year the Kick-In ended with the final party. A lot of master students turned up and celebrated the end of the Kick-In and simultaneously the start of the new study year.

Do you think you can give the master students a even better Kick-In experience, or do you just want another excuse to be part of the Kick-In again? Contact the board of Scintilla and help organising the EEMCS Master Kick-In 2014.

Junction

There are a lot of members of Scintilla, who are simply not that well known. Tjark Post is one of them. In this edition of the junction, we will learn a bit more about him. Tjark is a fifth year student, who just started his master this year. He is also a member of a religious student association: VGST

At what stage of your studies are you?

I started my master in Electrical Engineering this year. I haven't really chosen a direction yet. There are a lot of subjects I find interesting, so at the moment, I take courses from three different chairs: TE, RAM and SCS.

Do you have any hobbies?

In my free time, I like to play the trumpet. I used to take lessons and play in a show band, but I no longer do that. I also like to game. I don't have any specific games I like; I just like to play some games to relax.

I don't do a lot of electrical engineering related hobby projects, but I do fix things around the house.

One time, the on/off switch of our television broke, so I replaced it. But since it is pretty annoying that you have to get up from the couch to turn the television on or off, I made a multiway switch, with one switch located right next to the couch.

Are you a member of a student association?

I am an active member of VGST; the association of Reformed students in Twente. VGST organises all kinds of activities: bi-

Author: Vera Nauta

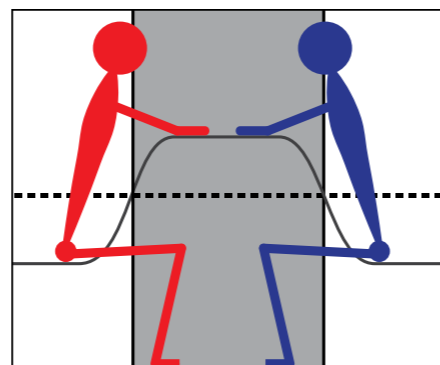

ble study, lectures, weekend getaways and theme groups. In these theme groups, we will discuss a book. This book doesn't need to be about religion, but can be about any social debate. Of course, there is also a drink every week.

For me it was a logical decision to become a member of this student association, since I am reformed. My brother was also already a member of VGSW; our sister association from Wageningen. He was very positive about this association, so I already knew I wanted to become a member of VGST.

What do you do within the association?

Every year, I am active in various committees. In the academic year 2011-2012, I was a member of the senate of VGST. In our senate year, we had a tandem. Not with two, but with four seats, so our entire senate could fit on the tandem. The tandem was used as a senate vehicle, and is now used for promotion purposes. Of course, the praeses would be the one holding the handlebar of the tandem. The ab-actis, who is in charge of the external communication, is the person in charge of the bell. The tandem is red with blue, which are the association colours. The tandem was one of the fun things from our senate year, but I have also learned a lot during this year. I was the fiscus (treasurer),



Tjark Post

Age

Twenty-two

Study year

Fifth

Birth place

Hoogland

Instrument

Trumpet

Student association

VGST

so I learned the associated skills. I also learned to justify my decisions to the association.

Does this influence your study progress?

I do think that being an active member of VGST has influenced my study progress. Especially during my senate year: I only earned 11.5 credits that year. But last year and last summer holiday, I've worked hard to catch up. So on August 29, I finished my bachelor. Just in time to start my master this year.

What was your bachelor assignment?

For my bachelor assignment, I've made a 3D scanner for faces at the chair Signals and Systems. This scanner consists of one laser line pointer and a camera. The laser line pointer generates a line, which moves across the face. The deformation of the line, which is dependent on the shape of the face, is ob-

served with the camera. The laser should be safe for your eyes. I did keep my eyes closed however, just in case. The laser line pointer is in a fixed position. The line can move across the face by changing the angle of the laser line pointer. Because of this, trigonometry is also used to make an accurate model of the face. My supervisor had already written an algorithm for face recognition, which can be used with my 3D scanner. The

chair already had built a low budget 3D scanner, but this one didn't work from one point so it was very big. The 3D scanner I made is a lot more compact. Other 3D scanners on the market are also more expensive. My end product did work, but it needed some more calibration; the results were fine but could be improved. The chair is now looking for someone who wants to continue with the project.



Baking Pies-Part 4

Solar powered baking

In part 4 and already the last part in this series we will take what we learned in part 3 about GPIO and use that knowledge to make a Raspberry Pi Powered PhotoVolataic (PV) monitoring system. With those GPIO's the Raspberry Pi can monitor the different utility meters to get a reading of current power, gas and water usage. A Bluetooth dongle is used to communicate with the PV inverter in the attic. With this combined data we can get a total view of current power consumption and generation.

In view of durability it makes sense to use a Raspberry Pi. After a big investment in clean energy we cannot justify to use a big computer with a lot of power usage for this task. This article is meant as a build log, we will discuss the background and PV installation, software and results but won't go into much detail. If you want more information you can always contact me.

Background

During the last days of June a big Grimbergen truck stopped at my parents house. The driver left at three o'clock in the night from Limburg and arrived early in the morning. The truck did not carry kegs of beer but the new PV installation my parents invested in.

Of course you now all hunger for some stats so I'll oblige:

- PV panels: 11x Solarfabrik mono black 260 Wp
- Inverter: SMA Sunny Boy 2500TL-ST. Transformerless, single string MPP tracking
- Statistics: SMA webconnect. It connects to a web portal which shows generation history.
- Orientation: West, 45° Array Tilt
- Total system size: 2860 Wp DC power, 2500 W inverter AC output power
- Expected yield: 2200 KWh/y
- Investment return time: 8 years

In the weekend that followed me and my dad did the installation ourselves. After spending 2.5 days on the roof and in the

attic some last adjustments needed to be made to the power box configuration. Then we were ready to turn on the system and generate our own power. We flipped the circuit breaker and the inverter switched on. In the figure below you can see the display from the inverter. It shows current power generation, daily and total energy generation and it cycles between AC/DC voltage and current. In the other picture you can see the array installed on our roof.

For the monitoring of the utility meters a couple of photo diodes are used. The most important one is the power meter. Two LEDs and two photo diodes function as a quadrature encoder. In software we can see which direction the power meter is turning.

Author: Peter Oosteweche

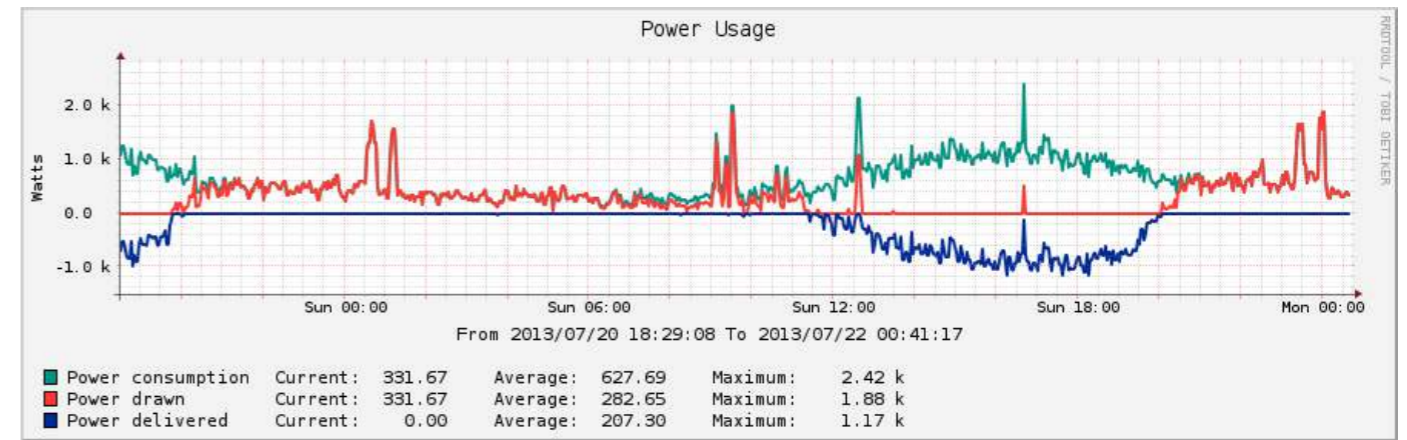

Combined with the inverter stats we can calculate current power usage and power draw or delivery to the grid. In the picture below you see the elegant setup for the power meter.

Software

So for now enough talk about the background of the PV array and on to the Raspberry Pi itself. The purpose of the software is the monitoring of the utility usage and communication with the inverter. The usage data is combined and graphed in Cacti (You've seen many graphs from this program in previous SOT articles) and the PV generation is uploaded to pvoutput.org[1]. The software is divided into two parts. Python is used for the main program to handle the GPIO's and upload data to pvoutput.org. Another piece of software called SMAspot[2] is used to communicate with the inverter over Bluetooth and pass the data to Python.

The Python program functions like this: At startup it initializes the RPi's GPIO pins to trigger an interrupt on an edge. Every mi-

nute the number of edges are converted to a consumption value. Cacti connects over a socket and requests these values. Another thread runs SMAspot to get the inverter parameters. This data is uploaded directly.

Results

As stated before Cacti combines the data in a graph. An example is shown in the power usage graph. The turquoise line is the power consumption at that point. The red and blue line is the power drawn and delivered to the grid respectively. After twelve you can clearly see the peaks where the dishwasher is running. In the morning there are peaks for the microwave, coffee maker and the electric kettle. The average power consumption is 630 W which is quite high. This is partly due to a freezer which is always running because it ran out of gas. Something we would not have discovered this if not for this project!

In the cacti interface there are also graphs for water and gas consumption. The other graph is the live output from the same day at pvoutput.org. As you can see that was a

very good day. The generated power follows the sun's power throughout the day. The total energy generation that day was 15 KWh. This figure is about the maximum we can get with our installation. Not bad compared to a daily consumption of 10KWh.

Conclusion

After about two months the setup is still running and uploading data. In those two months the PV array has generated 498 KWh of energy which resulted in a total net standstill of the energy meter. In those two months our house was completely energy neutral using the net at night and the sun at daytime. In the coming month I hope to extend the functionality of the system to also upload consumption stats to pvoutput.org. To view the output of our installation you can visit the first link in the reference list.

[1] PVOutput.org - <http://pvoutput.org/list.jsp?userid=22342>

[2] SMAspot - <https://code.google.com/p/sma-spot/>

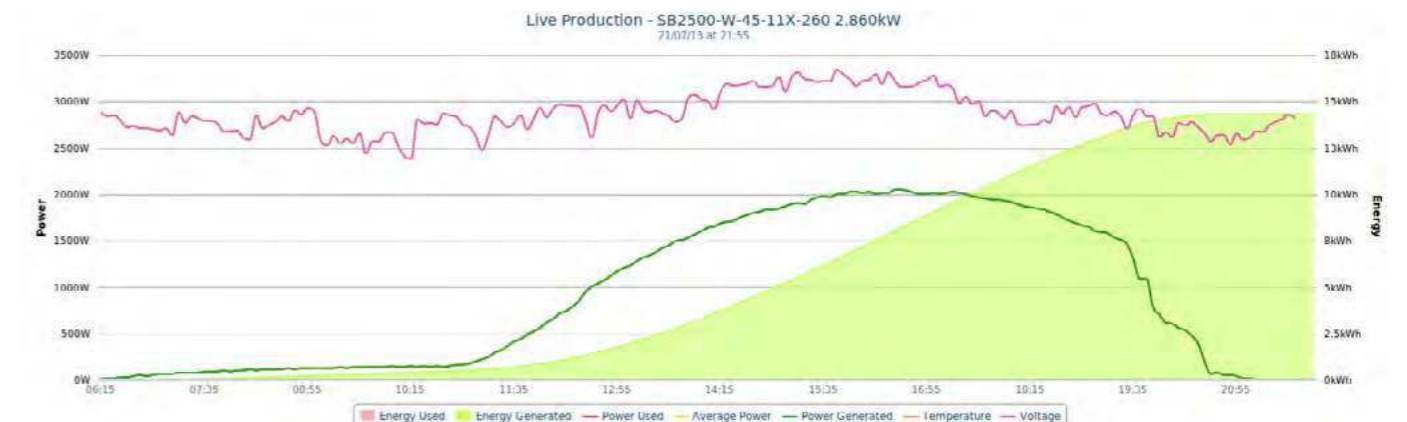

IAC2013

Author: Robert Grootjans

Last September four students (Roelof Grootjans, Sven Kevin van Langen, Rowan de Vries and Robert Grootjans) attended the International Astronautics Congress 2013 in Beijing. The reason for attending this congress is that three papers were accepted, and of course these had to be presented. The papers were all written for the TwenteSat project. They were about the following subject: “Perceived value of student participation in the field of aerospace engineering from a student’s perspective.”, “Determining position, rotation and orientation for tethered twin nano satellite to map data from an interferometer.” and “Inter-satellite communication link for a space based interferometer”.

The journey began at the 17th of September when the four of us travelled by train to Antwerpen, where we took the Thalys to Schiphol from where we got a direct flight. The reason for this weird detour is that the price of the ticket magically drops considerably. After the plane landed in Beijing, we had a couple of days to be tourists. Since three of us were China veterans, we did not have any trouble getting adjusted. After a

couple of days Mark Bentum and Alex Budianu from Telecommunication Engineering joined us. The first order of business was visiting the great wall of course. We arranged a trip so the six of us started our climb of the wall (first part by cable cart of course). After a large piece was climbed the four students decided that our body was not destroyed enough, so the knee/calf punishment conti-

nued in order to reach the unrestored section of the wall. After a while we returned to the starting point, so it was time to go down the mountain with a slide. As soon as the two hour trip back to Beijing was over we were invited to a dinner with the Dutch delegates who were going to be present at the IAC. But due to bad instructions the restaurant could not be found and our trip to the other side of the city was a waste of time. So the journey back to our part of the city began. Soon enough we found a restaurant in a dark alleyway and decided to go and have our dinner there.

The next morning the congress started. The first event was the grand opening. Of course we wanted to be present there, but since the registration procedure would take too long we didn't have the correct badges (green badges were for exhibitors, who weren't allowed in the opening event). The guard at one of the many entrances was not going to let us in. Luckily our problem solving skills soon guided us to another door where the guard wasn't that observant. Once we slipped through the security we took place in the huge room. The opening event was a spectacular event with a lot of different performances (acrobatics/sing/dance). Following a plenary session, the smaller technical sessions started. After hours of listening



The four students on the great wall.



The Opening ceremony.

we were tired of the technical sessions and decided it was time to drink the beer the Dutch delegates brought to the exhibition (well... not beer, Heineken). At the end of the day there was a reception with free food and drinks, which we of course didn't want to miss.

During this congress there is a lot to do. First there are technical sessions. These are sessions with 10-15 presentation in some category. There are a lot of technical sessions in parallel so you have to make a choice which one you prefer. Besides technical sessions there are plenary sessions. These sessions are large sessions where all people can

attend at once. The people presenting here are usually big shots like the bosses of the space agencies (like NASA/ESA). During the whole congress there is an exhibition. This exhibition is open for all the delegates and has stands from different countries/space agencies/companies. The Netherlands had a large stand, which quickly became our home away from home. The exhibition is of course a good place for networking and interesting things to see. Another advantage of the exhibition is of course free stuff (from goodies & pins to free drinks). The congress also organises social events and technical visits. The social events were trips to Kung fu



Roelof in an astronaut suit.



Opening ceremony



Beer at the dutch booth.

shows and a gala dinner. The technical visits involved trips to companies and institutes. We decided that a visit to China's rocket builder was worth the money. Furthermore we thought a Kung fu show would be entertaining as well.

The second day started with coffee at the Dutch booth. After a short time the first technical sessions started, after which the exhibition was explored. In the afternoon it was time for Kevin to present his paper. The paper ignited a productive discussion among the audience members, which the chair of the session liked. Overall the presentation went well. After the session it was time to hop on the bus to the Kung fu show. Once the Kung fu show was over we wanted to ditch the bus back to the convention centre because we were close to our hotel. Since this wasn't according to protocol, the Chinese tour guides were completely lost. They told us to wait while they called the boss to ask for help, because it was a tremendous problem for them that we didn't go on the bus. We decided not to stress them too much and patiently waited for them to find a solution. Eventually we wrote down our names and walked back to the hostel. While walking we found a cheap restaurant where we were having dinner in full suit. This was of course interesting for the locals who woke up their kids to take a look at us. After some beers in the shady streets of Beij-

ing we returned to the hostel.

The following morning started with coffee again. This was the day that we would be having a technical visit to the Chinese Academy of Launch Vehicle Technology. First we attended some normal technical sessions. In this session Alex was presenting a paper on the OLFAR project. After that we got on the bus for the technical visit. This is where the problems for the organisation started. They had the wrong list with people which caused initial problems when calling people on the bus (they insisted on calling everybody's name instead of checking it on the bus). What was even more problematic was that they also send the wrong list to the institute. This caused panic for the organisers since it has very strict security (well what do you expect with super large rockets) and they thought the technical visit could not continue. This was followed by a speech in which the organiser told the bus that she didn't know what to do, and she feared for her job. Luckily we were more confident and once we arrived it wasn't such a big deal after all. When the factory tour finished we went to a museum where we were allowed to take pictures as opposed to the factory. Finally we took a long bus ride back to the convention centre.

Thursday was a big day for Rowan and me. The presentations were scheduled for the afternoon, so in the morning we attended some technical visits. In the afternoon we



Chinese rockets



The dutch booth.

had one session in which both of us had to present our paper. The presentation time was 12 minutes and the chairman was very strict. Luckily the presentation time was short enough and there was some time for questions. The presentations also went well. After these presentations it was time to go to the exhibition and get some vodka from Ukraine who wanted to be the host country of the IAC in 2016. Unfortunately for them Mexico beat them for the bid. After the exhibition closed Mark was brave enough to join us for dinner, and told us to go to a restaurant where we normally ate. What we didn't know is that 10 other Dutch delegates would joined us. We decided that the area around the convention centre was too expensive and too fancy for us, so a subway ride to the centre was necessary. Once we located some dark dimly lit streets, we knew that we had picked a good area. The restaurant we chose didn't have pictures of the food they served or an English menu... perfect! Once we entered the restaurant some of the delegates were quite hesitant to enter and were thinking about leaving. Luckily they trusted us enough so the place was filled with 15 westerners in full suit. As expected the food was delicious. After dinner we decided to go to a rooftop terrace for some more drinks.

The final day started again with coffee at the Dutch booth. This morning we decided to explore the exhibition some more, which of course resulted in more free stuff. We

made friends with some Chinese students who wanted to show us how to let a magnetic globe levitate above a magnet (which was incredibly difficult, and of course Kevin managed to break it a couple of times).

In the afternoon we didn't have much to do so we explored the environment around the conventions centre, which contains the Olympic sports centres and stadiums including the Birdsnest. After we got back the closing event started and that was the last part we attended. The closing event was a bit boring, because it was basically a long award ceremony. After the closing ceremony we said goodbye to the people we met and returned to the hostel.

After all this we continued for a couple of more days sightseeing in Beijing, and three of us went 10 days to Xi'an after that. To summarise, it was an awesome experience to go to a big international congress, and of course China is an awesome country to visit.



Levitating globe with chinese students.

Network automation

The digitisation of the energy supply

Author: Liander

Electronics offer unprecedented opportunities. Network managers long struggled with the question of how electronics could be used in sub-stations to automate their operations. After all, the electromagnetic fields that arise from mid- and high-voltage systems interfere with electronics. That struggle ended when manufacturers like ABB and Siemens discovered that good grounding made it possible to combine electronics and high voltages. This paved the way for new automated functions in the network and laid the foundation for intelligent networks and smart meters.



SASensor: the ingenuity of a simple interface

SASensor The introduction of the new Station Automation Sensor (SASensor) in Liander's midvoltage networks has made thousands of control and monitoring cabinets redundant. The communication between operations and the network now goes through a small cabinet that stands out because it contains surprisingly little. In the past, the control and monitoring systems for the mid-voltage network were housed in a large number of cabinets and racks. Now, however, the revolutionary SASensor includes these functions (data storage, quality control and remote fault tracing) in the 'simplest' and smallest possible interface. All the software elements that were once in the interface have been eliminated from the SASensor. All intelligence has been placed in a central compu-

ter that is connected with the SASensor via a glass fibre cable.

Thanks to its simplicity, the sensor itself is relatively insensitive to ageing and should, in principle, have a useful life of about 30 years. The software and the central computer have a much shorter life expectancy, but can be easily replaced. In this way the SASensor is effectively blazing a trail for the intelligent networks. One great advantage of this simple box is that operational staff now often see a fault even before the first complaints come in, and technicians can generally resolve the problem within 30 minutes.

Fault localisation

The quicker the fault in the electricity network is found, the faster the repair technician can reach the affected location. Sounds straightforward and, thanks to the SASensor, it is. Using the SASensor's measure-

ments, a fault can be located within a radius of 0.5 to 1 kilometre.

This means that operational staff can quickly see which disconnected parts of the network can be reconnected and how the power supply can be re-routed to minimise any inconvenience caused by the power outage. The large-scale introduction of the SASensor in the network began in 2011 and will be completed in 2018. The SASensor will reduce the maintenance costs and investments in the network, while further increasing its reliability.

Investment

Liander will take seven years to roll out the SASensor system. Apart from the investment, Liander will also provide test facilities as well as input for developing and perfecting the SASensor. The sensor makes it possible to remotely operate the 10kV switches in the sub-stations and thus proactively monitor the quality of the power voltage.

Puuzle

I hope you liked the last two puuzels. Last time I did not mention the winner of the puuzel from Vonk 31-3. Therefore this time I will present two winners. The winner of the puuzel from 31-3 is Rick van Keken. The winner of the rebus is Thérèse Bergsma. Congratulations to both and you will be contacted about the winners cake! This time I made a crossword puuzel for you. Just think of the answers and fill them in at the right place. When you are finished, email the answer to truusje@scintilla.utwente.nl or post in the Vonk analog mailbox. Have fun!

Author: Truusje

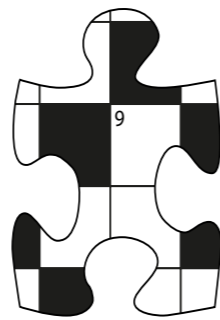

Horizontal:

- 1. ... walks into a bar, the barkeeper says: "we don't serve noble gasses here", he doesn't react
- 2. 4 December
- 3. Do-group
- 4. To come to be near or present in time
- 5. While (1) { PORTB^=1; delay(1000);}
- 6. Status component
- 7. STU
- 8. Brown - Black - Red
- 9. Divide by zero
- 10. Bakers Kilobyte
- 11. To Japan
- 12. Old-school transistor
- 13. 3.14
- 14. Shorter side of diode
- 15. !True
- 16. Printer
- 17. Wafer material
- 18. Basis in the cleanroom
- 19. Transimpedance amplifier
- 20. SK communication
- 21. s.c.v.m.d.d.v.s.h.g.
- 22. The set of all distinct elements in the collection
- 23. Scintilla colour
- 24. Small one directional bomb
- 25. To process an illuminated photoprint
- 26. Helps with soldering

- 27. Data structure
- 28. 6.02214×10^{23}
- 29. That is what she said
- 30. Logo
- 31. (0,0)
- 32. Student drink
- 33. Amplifier
- 34. Machine made by ASML
- 35. A Direction and magnitude
- 36. The moving of electrons

Vertical:

- 2. Study association
- 7. The room used by Scintilla
- 8. Founding year Scintilla
- 14. Capturing device
- 15. Bike with capacity
- 22. Where you study
- 23. 2.6 M Ohm
- 26. How much hertz?
- 37. Queen which acknowledged Scintilla
- 38. Alternative name of the "Westzaal"
- 39. Old-school Windows
- 40. E.G. BC550
- 41. Name of the mascot of the Borrel
- 42. Cosy drink
- 43. Unmanned aerial vehicle

- 44. Electronic reference book
- 45. Crash course EM field
- 46. Communication port
- 47. Not A Space Agency
- 48. Something to do before exams
- 49. Treasurers problem
- 50. Not (x)
- 51. Songbook
- 52. Somewhere between values
- 53. Resistance
- 54. Voltage
- 55. Usually good enough
- 56. Subject to three laws by Asimov
- 57. Not real
- 58. Speak about something to someone
- 59. Frequency demodulator

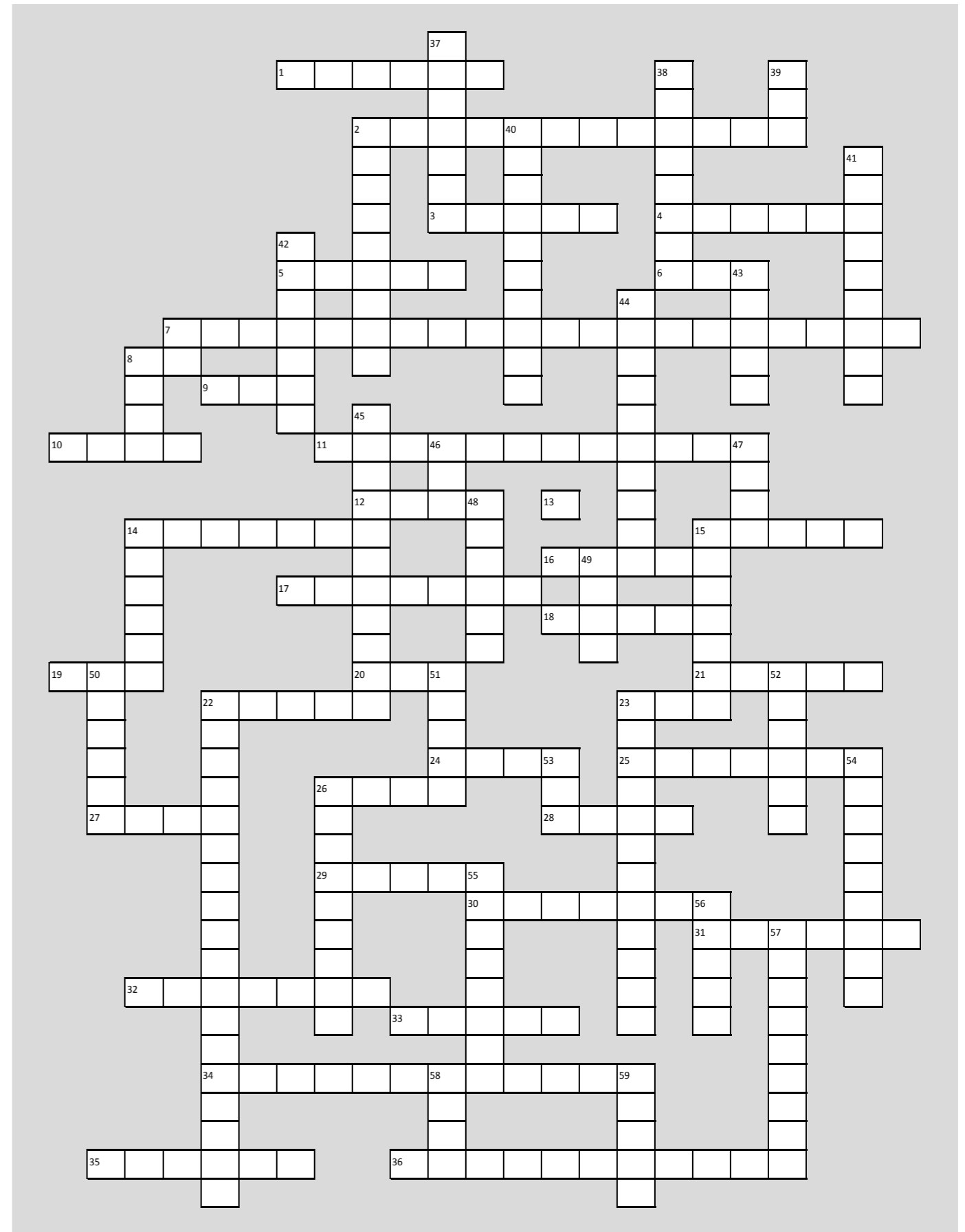



Waar haal jij de energie voor 600.000 jongensdromen vandaan?

Trainees In de laatste minuut de winnende goal maken; wie heeft er niet van gedroomd? Bij Liander dromen we vooral van slimme energieoplossingen. Zo werken onze trainees bijvoorbeeld aan sportparken die via LED-lichtmasten en zonnepanelen energie besparen én zelf opwekken. Als grootste netwerkbeheerder van Nederland zorgen we bij Liander voor het transport van elektriciteit en gas naar miljoenen bedrijven en

particulieren. Maar we doen meer. Op weg naar een duurzame toekomst nemen we graag het initiatief. En dat verwachten we ook van jou als trainee. Of je nu voor ons technisch, fi nancieel, ICT of management traineeship kiest: we dagen je uit om met vernieuwende ideeën te komen. En als jij wilt investeren in een mooie toekomst, investeren wij graag in jou. Ontdek jouw uitdaging op werkenbijliander.nl

iedereen energie

liander