

De Vonk



Periodical of  E.T.S.V. Scintilla

Main Article:

Miniaturized biological analysis devices

Moteq Re-Engineering
Challenge

Education:

The passing of a programme director

Year 35 | Edition 3 | July 2017



BOARD 85



De Vonk
Periodical of E.T.S.V. Scintilla

Main Article: *How Coping with Parkinson's disease*
 Promotion: *A Study on the use of the...*
 On Location: *The first year in D...*

Year 34 | Edition 2 | May 2016



De Vonk
Periodical of E.T.S.V. Scintilla



De Vonk
Periodical of E.T.S.V. Scintilla



De Vonk
Periodical of E.T.S.V. Scintilla

Main Article: *MRI compatible biopsy robot*
 Master: *Coping with Parkinson's disease*
 Moteg: *re-engineering challenge*

2 year 35 edition 3

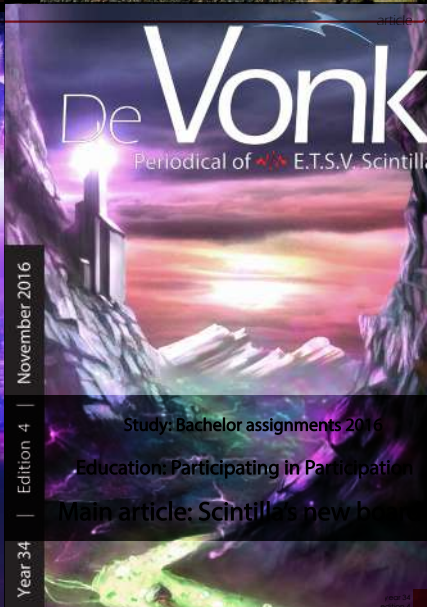

De Vonk
Periodical of E.T.S.V. Scintilla

Year 34 | Edition 4 | November 2016

Study: *Bachelor assignments 2016*
 Education: *Participating in Participation*
 Main article: *Scintilla's new...*



Periodical of E.T.S.V. Scintilla

Main article: *The piezo-electric field effect transistor*

Internship: *How to debug a complete smartphone transmitter*

Presidential note.

Author: Guus Frijters

Hi again, almost a year has passed. Only a few months left, dependent on when you are reading this. This means that this is my last presidential note. To prolong this special moment I would like to advise you to read a little slower than you would normally do.

This way my last presidential note might feel a little longer. I hope you enjoyed the Presidential notes that I wrote and maybe you even learned something. I learned a lot this year, with all my presidential notes I learned how to write some less-necessary stuff in a small article, with my board year overall I learned a lot more.

In the beginning of the year I learned to drink beer like a board member. All the constitution drinks made sure of that. I also got a feeling of how to plan certain things but mostly how to make sure I would keep myself to the planning. Later on in the year, I got the chance to really develop myself because I became better in the day-to-day tasks so I could do more specialized and presidential tasks. After a while, this also became semi-routine, which made board-life feel like normal-life.

Now, with the end in sight, the heat starts to rise and the motivation starts to drop. The learning curve is semi-complete. We all know this feeling, since it happens to the best of us. After a long year of working you feel that the vacation is drawing closer, the weather is getting better and the confidence drops to an ultimate low. The amount of students who come in the SK with complaints about their study is higher than it ever was. Which feels familiar because I always had and probably will have the same problem.

With the end in sight, the heat in the SK

reaches temperatures which are not describable with Celsius. It is only describable with Kelvin. On one hand this is lucky, because then we have no clue how hot it really is. Sadly, we are electrical engineer students. So our curiosity and intelligence causes us to quickly make sure we can convert Kelvin to Celsius within a quick look. So now we do know what the temperature is, and it is hot.

The end of the year is not only noticeable by the weather and the students motivations, but also with all the new boards that come by to get acquainted with all the brother associations on the campus. This causes nice stories and, of course, a lot of laughter. The importance of these so called "feuten" rounds is that, as a new board, you get to know all the brother-associations on the campus and that you have a bonding-activity with your board. Next to this, it is also nice to learn something about the associations. I hoped you enjoyed all the presidential notes I wrote. I know I enjoyed writing them most of the time. Sometimes inspiration is hard to find, but in the end it all works out in some way.

Dames en heren, Op de Koningin, Op Scintilla



Guus Frijters



Constitution Drink

On September 5th the candidate board hopes to be constituted as the 88th board of E.T.S.V Scintilla. To celebrate this there will be a constitution drink on September 7th

Dies Natalis Scintilla

During the friday afternoon drink on September 8th we will celebrate the 52th birthday of Scintilla. Come by to celebrate this with us. Cakes and drinks will be present!

Masthead

De Vonk

Periodical of E.T.S.V. Scintilla. Published four times a year in the amount of 700 copies.

Year 35, Edition 3
July 2017

Editorial team

Mark van Holland, Jippe Rossen, Céline Steenge, Maarten Thoonen, Nahuel Manterola, Rik Engel, Wim Hoek, Gino van Spil, Marissa Jonker

Cover Artist

Jippe Rossen

Board Representative

Wouter Pool

Print

Gildeprint, Enschede

Editorial office

E.T.S.V. Scintilla, University of Twente,
Postbus 217, 7500 AE Enschede,
☎ 0031 53 489 2810
vonk@scintilla.utwente.nl

Material

vonkkopij@scintilla.utwente.nl

All members of Scintilla receive De Vonk free of charge by post.

Nothing in this magazine may be duplicated or copied without explicit permission from the editorial team of De Vonk.

The editorial team reserves the right to change or exclude material provided by third parties, in part or in whole. The opinions expressed in the articles are not necessarily shared by the editorial team.

ISSN 0925-5421

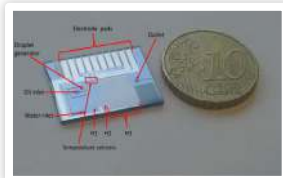

08 Main article

Bios explains on how scaling down the dimensions of fluidic channels presents new possibilities in many different ways,



24 Education

Mark Bentum is leaving the university of Twente. The editorial team of The Vonk interviewed Mark one last time on how he has experienced the past few years as programme director.

03

Presidential Note

06

Main Article

Miniaturized devices for chemical and biological analysis

14

Activities

Batavierenrace

15

Junction

Kirsten Voncken

18

Photo Page

20

Activities

Moteq Re-engineering challenge

22

Advertorial

ASML

Moteq re-engineering challenge 20

Read the recap on this years' legendary installment of the Moteq re-engineering challenge!



Junction 15

Kirsten Voncken tells about her life as a student, study advisor and everything in between.

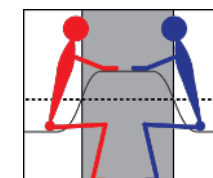

On Location
SKIC Camp site

Education
The passing of a programme director

Scolumn
Girl Troubles

Activities
Grolsch Excursion

Datasheet
Cooking with Céline

Puuzle

23

24

28

29

30

33

Editorial

Hello dear sparkling friends!

Temperatures are rising once again. This can only mean a single thing and that is that the summer holidays are approaching fast. So to make you relax just that little bit better at the coast of Turkey, in the mountains of Scotland or on a Greek island, we have a wonderful brand new edition of The Vonk for you!

You may observe some changes in this edition. For starters the inner cover is different from what we usually do, It is our custom to put an advertisement here from one of our sponsors (thanks guys, you are awesome!). However, our cover artist has decided to quit making the most magnificent pieces of art for our magazine. To honour his devotion, we have filled the page with nine covers he has provided us with the last few years.* Robert Fennis, also a big shout out to you!

Another fun fact for this edition, is that we have managed to acquire baby photos of all upcoming board members. It goes without question that we could not keep this from all of our dear Vonk readers. We decided to share them with you by encapsulating them in a nice puuzle, so make sure to check out the puuzle of this edition. A bonus is that you can, like any other puuzle, win a pie with it!

That is it for now guys, enjoy!

Jippe

*He has made ten, but there was no more room available for his tenth cover. So his last cover, the majestic skyscraper of edition 35.2, is absent here.

Lab on a Chip:

Miniaturized devices for chemical and biological analysis

Scaling down the dimensions of fluidic channels presents new possibilities in many different ways, a concept that was pioneered in the early 90s when Andreas Manz et al. proposed the miniaturized chemical analysis systems (μ -TAS) [1]. Although these devices were mainly intended to improve separation performance in chemical analysis (e.g., on-chip electrophoresis or chromatography), this idea of microfluidic integration is now applied much broader [2].

Using various microfabrication techniques based on photolithography, most of which are well-known from microelectronic fabrication, multiple functionalities can be combined in a single Lab on a Chip (LOC) device. These devices contain fluidic channels with a size comparable to the diameter of a human hair ($\sim 50 \mu\text{m}$ or less) and can be equipped with electrodes for, e.g., detection purposes or to drive electrochemical reactions.

The idea behind a Lab on a Chip is depicted in figure 1. As an example, a pharmaceutical lab could be considered where new candidate drugs are being te-

sted. Typical tests include the screening for potentially toxic metabolites, which could be generated in humans as part of the drug metabolism pathways through enzymatic oxidation, often taking place in the liver. Testing for potential adverse effects can therefore be done in the lab by, e.g., incubating the candidate drugs with primary hepatocytes (a type of cell in the liver), followed by retrieval and analysis of the reaction products [3]. Alternatively, these kinds of drug metabolites can be generated in an LOC device by electrochemical oxidation at an electrode surface. Advantages of using shallow channels compared to bulk chemistry (the chip vs. the flask in figure

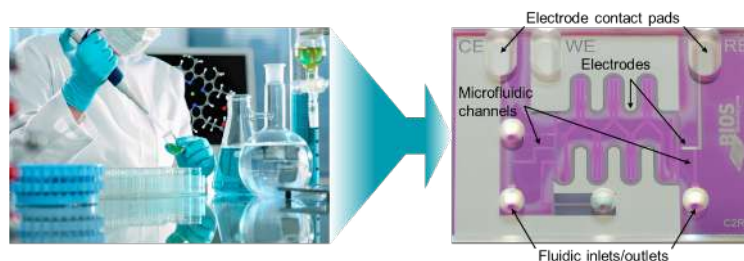

Figure 1. From a lab to a chip. (Bio)chemical reactions are miniaturized to benefit from accurately controlled conditions such as reactor geometry, flow rate, temperature, etc. (Source: www.saptalis.com (left) and photo by Henk van Wolfereen (right)).

Author: Marinke van der Helm, Vasilis Papadimitriou, Jeroen Vollenbroek and Floris van den Brink



1) include rapid mass transport over small distances, fast overall analysis (due to short times to detection) and reduced consumption of (often expensive) reagents. To illustrate the first point: diffusion times (t_d) scale proportional to the diffusion distance (x_d) squared ($t_d \sim x_d^2$). This means that (electro)chemical reactions can take place efficiently and under uniform and well-controlled conditions when the reaction volumes are small (typically $< 1 \mu\text{L}$) or the drug molecules are in close proximity to an electrode. It takes a typical drug molecule in a microfluidic channel of $5 \mu\text{m}$ height on top of an electrode only tens of microseconds to diffuse to the electrode surface, where it has the possibility to be oxidized. Knowing this, microfluidic chips for applications such as these should be designed in such a way that high conversion efficiencies can be reached, even if these reactions involve adsorption/desorption steps and/or take place with slow reaction rates [4,5].

Following this brief introduction to the field of Lab on a Chip, three currently active research topics of the BIOS – Lab on a Chip group will be explored

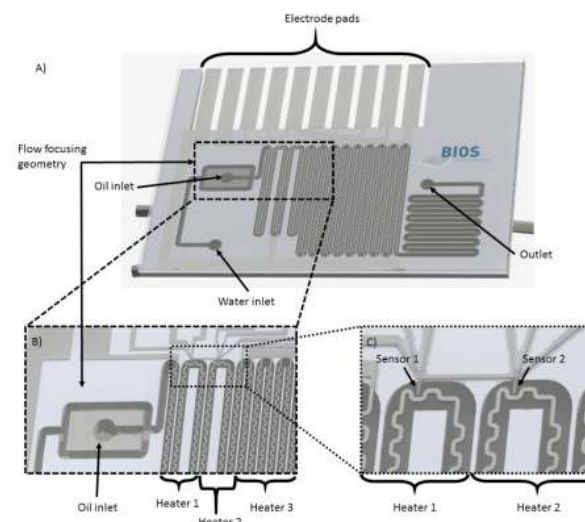

Figure 2. Rendered image of the design of the droplet-microreactor. A: Whole chip with inlets for water and oil, a flow focusing geometry for droplet creation, outlet, a meandering channel, and contact pads for heaters and sensors. B: Flow focusing geometry and three separate heater sections. C: Sensor structures used for measuring the temperature of the heaters.

in more depth. Our group is embedded in the EEMCS faculty and member of both the MESA+ Institute for Nanotechnology and the MIRA Institute for Biomedical Technology and Technical Medicine, which emphasizes the multidisciplinary nature of our research. The three projects highlighted next will further demonstrate this and it will become clear that Electrical Engineering expertise is an essential ingredient for successful Lab on a Chip development.

Single particle analysis in a droplet-microreactor

In order to study individual particles at high-throughput, a microreactor was developed that can encapsulate particles in droplets. By isolating individual particles in droplets we can study the heterogeneity between particles, meaning that not even a single particle is exactly the same compared to the others. The use of droplets will allow us to do this at high throughput, since it has already been shown that up to 1000 droplets

per second could be created on chip [6]. Each droplet can be regarded as a separate reaction chamber to test chemical behaviour. If the experiments on the particles were to be done in batch processes, only information about the average of all particles could be obtained. Furthermore, the microreactor has built-in heaters and temperature sensors to operate at higher temperatures; all features are miniaturized and integrated in a single chip. The fabrication and use of such a droplet microreactor spans multiple fields, amongst others material science, interfacial physics, and electrical engineering. Various aspects of the development of this device will be highlighted below.

Droplet microfluidics

In the field of microfluidics the use of microdroplets is common practice. Microdroplets are used in many applications such as chemical microreactors and single reaction vessels for biological assays of cells and DNA [6-9]. By mixing two immiscible fluids such as oil (non-polar) and water (polar), emulsions of

either oil-in-water (O/W) or water-in-oil (W/O) droplets are created [7,8,10]. A droplet is the result of the shear forces and interfacial tension between the two fluids, creating a stream of liquid A (continuous phase) with droplets of liquid B (dispersed phase) [8]. To create, for example, oil-in-water droplets, the walls of the fluidic channel need to be hydrophilic, so that the continuous phase (water) wets the surface. Droplets form an ideal homogeneous reaction environment because of their well-controlled properties such as their shape, size and monodispersity [8]. Furthermore, if the particles are used in chemical processes, the dispersion of the product in the fluid flow is minimized [8]. The elevated temperatures and pressures also help for the chemical analysis of the particles, since these conditions increase the reaction rate. The configuration of the channels that are used for the creation of droplets also plays a role. Examples of droplet generator geometries are the 'capillary', the 'T-junction', and the 'flow focusing junction' [8]. An example of a flow focusing geometry is shown in figure 2, where the continuous phase is coming from the water inlet (forming 2 side arms) and the droplets are created from the liquid coming from the oil inlet.

Design and Fabrication

A rendered image of the design of the chip is shown in figure 2A. The electrode pads for connecting the heater and sensor structures can be seen at the

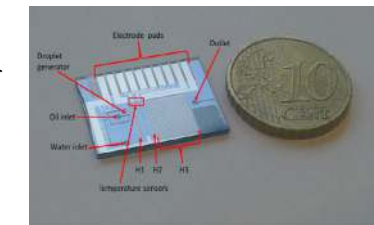

Figure 3. Fabrication result of the microreactor, showing the chip with all its features as shown in detail in the design (see figure 2).

top. The chip has three separate heater sections: heaters 1 to 3, as shown in figure 2B. Each of these can be addressed individually. In figure 2C it is shown that the temperature sensors are interwoven with the heaters. By placing the sensor close to the heater the measured temperature is close to the true value. The microreactor was fabricated in the cleanroom of the MESA+ Nanolab. The devices were made from a silicon and a glass substrate bound together by anodic bonding. The heater and temperature structures are thin-film platinum traces covered by a thin layer of SiO₂ to electrically insulate them from the fluid in the channel. At the places of the contact electrodes, the SiO₂ is etched away so that they are accessible for electronic interfacing with a control system. The fluidic channels etched into the silicon wafer are 150 μm deep and 150 μm wide. The fabricated chip is shown in figure 3.

Characterization of the temperature sensor

For readout and control of the temperature a data acquisition board (NI myRIO) is used. The resistance of the platinum sensor structures is dependent on the temperature. Calibration of the temperature sensors is done by fully immersing the microreactor in a beaker of

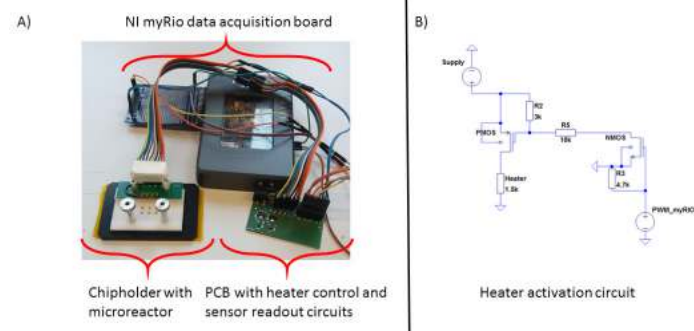

Figure 5. A: Chip holder, NI myRIO and PCB with the control electronics used in the read-out and control of the heaters and temperature sensors on the chip. B: Part of the activation circuit on the PCB used for on-chip heating.

oil on a hotplate. A thermocouple thermometer, connected to the hotplate, is used as a reference thermometer. A magnetic stirring bead is used to promote the uniformity of the temperature in the oil. The hotplate is heated from 30°C up to 150°C and cooled down to 30°C, to rule out any hysteresis effects. Meanwhile, the resistance of the temperature sensor located on the microreactor is measured with a four-point measurement, where a known current of 2 mA is sent through the sensor and the voltage across it is measured. The sensors show a sensitivity of 0.0476 Ω°C⁻¹ and are highly linear given the R² of 0.9989 for both sensors. The offsets are 18.311 Ω and 18.294 Ω for S1 and S2 respectively. The resolution of the sen-

sors is 0.15°C, partially determined by the gain of the electric circuit used for amplifying the voltage across sensors and by the 12 bits ADC of the myRIO. Figure 4 shows the calibration curve obtained from this experiment.

Control of the heaters

The chip is placed into a plastic (Delrin) chip holder, chosen for its low thermal conductivity. Conducting pins are present in the holder which can contact the electrode pad on the chip and allow further interfacing with the myRIO. For control of the heaters a PI controller is made in LabVIEW and executed on the myRIO. The PI controls the duty cycle of a 1 kHz square wave put onto the gate of an NMOS transistor. The NMOS acts as a switch between a power source, a PMOS, and the heaters. By varying the duty cycle, the power to the heaters can be controlled. The temperature sensors in the microreactor chip provide the feedback temperature for the control loop. The schematic for the control circuit is shown in figure 5B. The chip holder, myRIO, and a PCB with the control circuit are shown in figure 5A. Figure 6 shows the response and readout of the control system when the temperature is raised from 50°C to 75°C. The duty cycle increases

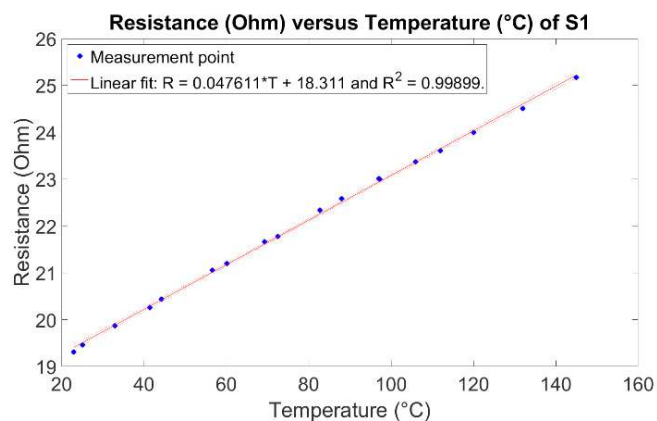

Figure 4. Calibration curve of the temperature sensor S1 showing the resistance versus the temperature. The sensor shows a sensitivity of 0.0476 Ω°C⁻¹, an offset of 18.311 Ω, and R² of 0.9989.

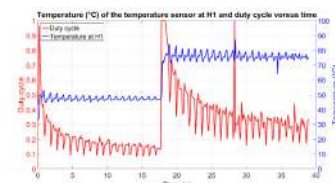

Figure 6. Step response of the control loop showing the temperature at Heater 1 and the duty cycle controlling the power in Heater 1. After 18 seconds the set point was changed from 50°C to 75°C.

immediately, resulting in an increased power dissipation, and therefore an increased temperature of the heater. The response time of the system before it reaches the set-point is approximately 1.5 seconds, after which the temperature oscillates around the set-point with a standard deviation of 2.6°C.

Droplets at elevated temperatures and pressures

Finally the temperature is varied whilst droplets (oil-in-water) are created inside the chip. Figure 7 shows droplets at different temperatures and pressures. It can be seen that the droplets are stable at both room temperature and at 50°C. When the temperature is increased to 120°C and the chip is still at atmospheric pressure (1 bar) the droplets collapse because the water is boiling. Some de-wetting effects can be seen at the channel-liquid interface and large gas bubbles are formed. When a backpressure regulator is added and the whole chip is at a pressure of 5 bar, the droplets are stable at 120°C, because the water does not boil at that temperature and pressure. A preliminary experiment with particles showed problems with the density and weight of the particles, since they tended to sink to the bottom of the tubing and the channel and then get stuck at the wall, but because of the heterogeneity of the particles we managed to capture a few of them in droplets at a rate of 150 droplets per second.

So far we have a droplet microreactor that is able to operate at various temperatures and pressures and shows good control of the temperature. The created droplets are stable and we can work above the boiling temperature of the liquids at 1 bar by increasing the pressure inside the chip.

The next step is to put the particles inside the chip and in droplets. Work on capturing and analysing particles is still in progress.

Electrical measurements in Organs-on-Chips

The multidisciplinary research field of organs-on-chips is quickly growing and gaining more attention, as evidenced recently by two large grants for organ-on-chip research at the UT [11,12]. In these microfluidic chips human (stem) cells are combined with microfluidics and micro-engineering to enable the replication of human tissue and organ function in a realistic and yet controllable in vitro environment [13,14]. These chips can also be equipped with (electrochemical) sensors to closely monitor

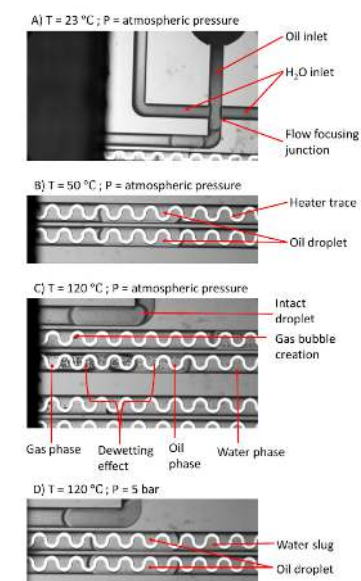

Figure 7. Droplets created under various conditions. A: The heaters are switched off. B: The temperature is kept at 50°C. C: The temperature is above the boiling point of water (120°C). D: The temperature is above the boiling point of water (120°C) and the system is under an outlet pressure of ~5 bar.

the growth and function of the cells cultured inside the channels. Examples of interesting readouts are pH, O₂ tension, glucose consumption and the excretion of all kinds of signal molecules by the

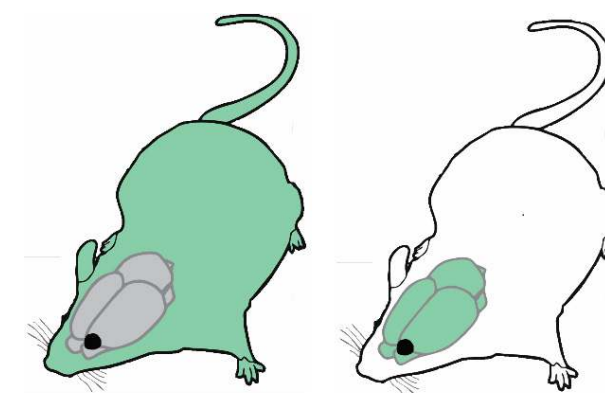

Figure 8. Schematic illustration of the function of the blood-brain barrier. Left: A dye (green) injected into the body of a mouse enters the bloodstream and eventually stains every organ, except for the brain (grey). Right: When a dye (green) is directly injected into the brain, it is confined there and prevented from entering the bloodstream (Reprinted from [15], originally adapted from [16]).

cells. Also, organ-level function can be monitored electrically, for example the formation or disruption of the barrier function of endothelia or epithelia, as will be explained in the next sections using the blood-brain barrier (BBB) as example tissue.

Blood-brain barrier on chip

The BIOS – Lab on a Chip Group is developing a blood-brain barrier on a chip (BBB-on-chip). This biological barrier is formed by the endothelial cells lining the blood vessels in the brain and provides an optimal environment for neuronal function by its tightness and selective permeability. As a result, it prevents potentially harmful agents in the blood from entering the brain, as is illustrated schematically in figure 8 [15,16]. Unfortunately, the BBB also limits drug

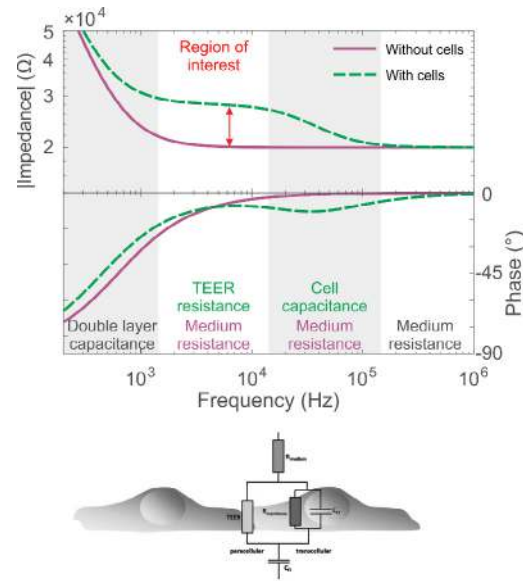

Figure 10. Top: Typical impedance spectra for TEER measurements in BBB-on-chip without cells (pink) or with cells (green dashed; both modelled using Matlab 2016b) (Reprinted from [19]). Bottom: Equivalent circuit model of a cellular barrier on which the modelled impedance spectra and the data analysis are based (Reprinted from [20]).

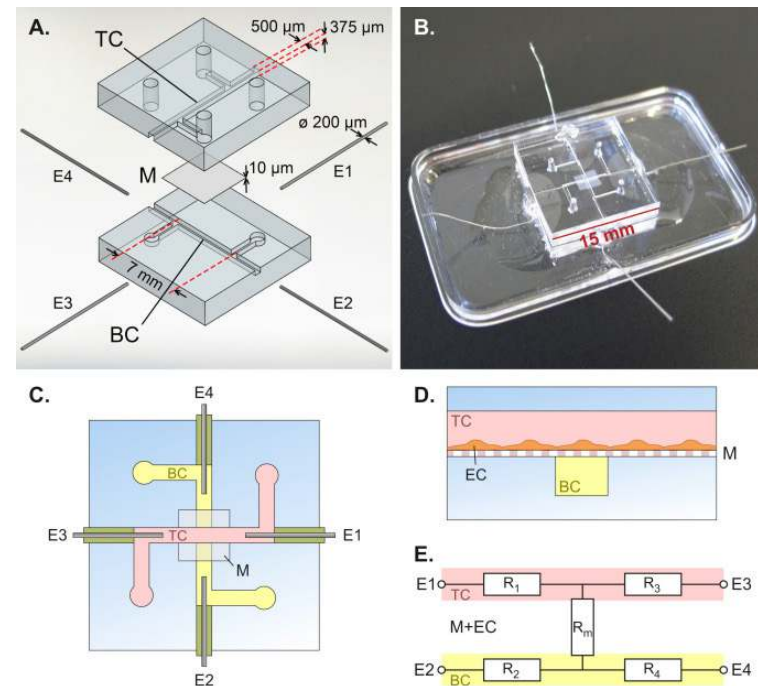

Figure 9. Blood-brain barrier chip. A: Exploded view with top channel (TC), bottom channel (BC), membrane (M) and integrated platinum electrodes (E1-4). B: Picture of actual chip. C: Schematic top view. D: Schematic cross-section at the center, showing endothelial cells (EC) forming the BBB between the channels. E: Simplified equivalent electrical circuit (Reprinted from [18] with permission from Elsevier).

delivery into the brain, thus complicating drug development for neurological diseases such as Alzheimer's, Parkinson's and brain tumors. To that end, functional and predictive models of the BBB are required to enable the study of drug transport across this barrier. Before starting such drug permeability experiments, the “transendothelial electrical resistance” (TEER, in $\Omega\cdot\text{cm}^2$) can be measured as a quick, non-invasive and label-free measure of barrier integrity. This TEER represents the electrical resistance across a cellular barrier and a sufficiently high value ensures proper barrier function [17]. To facilitate on-chip TEER measurements, we have incorporated electrodes in our BBB chips.

Impedance spectroscopy on the blood-brain barrier

The BBB chip, displayed in figure 9 [18], consists of two polydimethylsiloxane (PDMS) parts with channel imprints,

glued on top of each other with a porous membrane in between. This membrane acts as a support for the endothelial cells cultured in the top channel (representing the blood side), allowing transport to the bottom channel (representing the brain side). Four platinum wire electrodes are inserted into these channels and fixated in place with a glue. Using the six possible measurements between two electrodes, a system of equations results from which the resistance of the cell barrier and membrane can be derived algebraically, independent of the (relatively) large resistance of the electrolyte-filled microchannels.

The six measured resistances are determined from impedance spectra recorded with a lock-in amplifier, of which a modelled example is shown in figure 10 [19]. These modelled impedance spectra are based on the equivalent circuit model of a cellular barrier also displayed in figure 10 [20]. At the lowest frequency, the spectra are dominated by the capacitance of the electrical double layer at the platinum electrodes (C_{el} in the equivalent circuit). Then, the cell barrier resistance dominates (if present), which arises from the tight layer of endothelial cells and gives rise to the measured TEER (TEER resistance in the equivalent circuit). Subsequently, the barrier capacitance dominates, arising from the electrically insulating lipid bilayer membranes (C_{cl}, which is the equivalent of one teaspoon of salt in 2000 Olympic-size pools. Hence, a local increase of concentration (pre-concentration) on top of the sensor dominates at high frequency (R_{medium}). To determine the resis-

tance of the measured paths including the cell barrier (if present), a suitable readout frequency is chosen in the “region of interest”. From the six thus obtained resistances, the TEER can be determined as a measure of barrier integrity as was described before. In our current work, we are focusing on retrieving the barrier capacitance from such data and correlating microscopy observations to changes in measured capacitance.

Detection of cardiovascular diseases (CVD) biomarkers on chip

For the early diagnosis of CVD, a handheld point-of-care device (<http://www.phocnosis.eu>) is being developed. The diagnosis will be done by detection of a few biomarkers (proteins) from whole blood. But there are two major problems that need to be solved:

- In blood there are approximately 10.000 different proteins [21] and we are interested in just three of them. Hence, a separation of the wanted proteins out of their complex environment is needed.
- The proteins under investigation exist in very low concentration. E.g., Cardiac Troponin I (cTn-I) has a typical concentration of 1 ng/L, which is the equivalent of one teaspoon of salt in 2000 Olympic-size pools. Hence, a local increase of concentration (pre-concentration) on top of the sensor is needed.

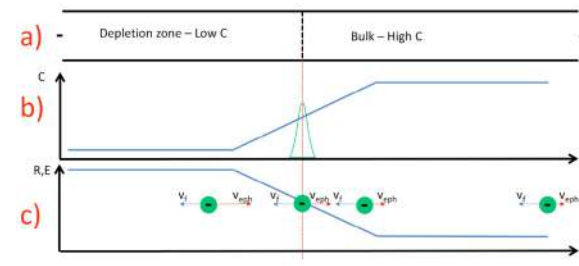

Figure 11. Schematic representation of depletion zone isotachopheresis

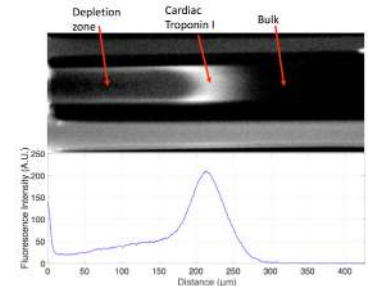

Figure 12. Dz-ITP of 100 ng/L of fluorescent cTn-I in phosphate buffered saline. Top: Fluorescent image microscopy image take after 2 min. Bottom: Fluorescent intensity profile. The fluorescent intensity corresponds to cTn-I concentration. As show in the profile, the bulk concentration of cTn-I is practically 0 A.U. and after 2 min it has increased more than 200 A.U.

A method named depletion zone-isotachopheresis (dz-ITP) was developed that is capable of both separation and pre-concentration [22]. With the use of electric fields and the functionality of special materials (ion selective membranes) we can create a phenomenon called ‘concentration polarization’, which practically creates a region in a channel that has extremely low concentration of ions (depletion zone (dz)) [23]. An interesting functionality arises when an electric field is applied across the depletion zone, which is described in figure 11. In the channel (figure 11a) there is a region with low concentration of ions and a region with high concentration. Between the two regions there is a concentration gradient (figure 11b). The electrical resistance of the liquid depends on the concentration of ions, and therefore the region with low concentration of ions has high electric resistance. When an electric field is applied along the length of the whole channel, this area then has a high electric field. At the high concentration region we have a low electric field and between the two regions an electric field gradient (figure 11c). The field exerts an electrical (Coulomb) force on the ions. Simply put, a negative ion will try to move towards the positive electrode and opposite to the v_f . The

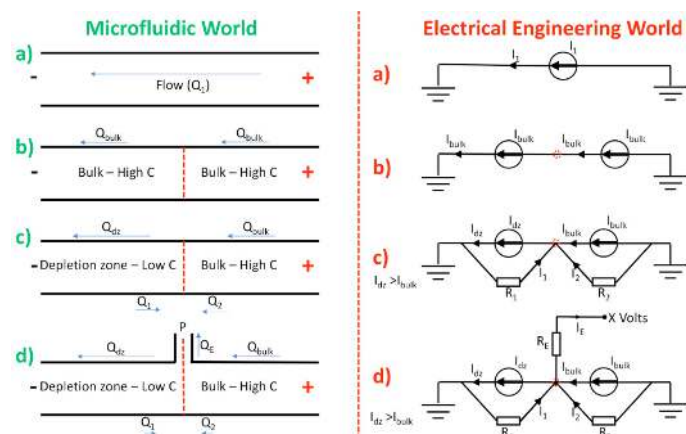

Figure 13. Schematic of the microfluidic system and its equivalent electrical circuit.

ions start moving through the solution with a certain velocity called the electrophoretic velocity (v_{eph}).

In addition to applying the electric field, the solution also moves with constant velocity (v_f) through the channel (this is another effect of the applied field which is called electroosmotic flow and that we will treat later). When a negative ion moves up the E-field gradient, v_{eph} is increasing and at some point (the focusing point) it will be equal to v_f . The ion at that point is effectively trapped. If it moves to higher E-field region, v_{eph} will be higher than v_f and will be pushed back to the focusing

point. Similarly, if it moves to lower E-field region, v_f will be higher than v_{eph} and it will be pushed forward to the focusing point. Different kinds of ions (i.e., with different electrophoretic velocities) require different E-fields to acquire the same v_{eph} , so they focus at a different point. Hence, separation is achieved. In addition, all ions of the same kind have the same focusing point, so the concentration at this point increases over time, hence pre-concentration is achieved. An example of separation and pre-concentration of cIn-1 is shown on figure 12.

Someone with some experience in microfluidics can notice the parabolic sha-

pe of the focused analyte which clearly indicates the effect of pressure-driven flow. At a first glance it is not clear why this is the case, since no external pressure is applied, and modelling the system mathematically is quite a tedious process. Luckily, microfluidic systems can be easily translated to electrical circuits that someone with electrical engineering background can easily solve. In order to make an equivalent electrical circuit from a microfluidic system we have two simple rules. First, the pressure in the microfluidic system is translated to a potential in an electrical circuit and second, the volume flow is translated to a current. Both Ohm's law (with hydraulic resistance instead of electrical resistance) and Kirchhoff's laws then apply. When a potential is applied along a channel, there is a bulk liquid flow (electro-osmotic flow). This flow scales linearly with the electric field (figure 13a). The equivalent circuit for this is a simple current generator (figure 13a). We can "split" the channel in two parts at an arbitrary point with no change in the system (figure 13b), which will be equivalent to two current sources in series (figure 13b). As long as they supply exactly the same current, the system is stable. During dz-ITP one part of the channel has low concentration (high E-field) and another part has high concentration (low E-field), which means there is a faster flow in the dz than in the bulk (figure 13c). The equivalent is two current sources supplying different currents connected in series. Kirchhoff's law now dictates that there will be two feedback currents (I_1 and I_2) bringing the system into equilibrium (figure 13c). At the node, due to the potential drop across R_1 and R_2 , a low potential results. This translates to a low pressure in the fluidic system, which explains the shape of the peak in the microfluidic channel. Since the node is the focusing point of the analytes, we can exploit this and extract the focused analyte by adding a channel and applying a negative pressure (figure 13d), which is equal to

adding a resistance (RE) and applying a negative potential (figure 13d). The result of such a system and the extraction is shown in figure 14.

Concluding remarks

The three examples presented in this article give some idea of the challenges that are being addressed in our group to further the fundamental knowledge and technical applications of Lab on a Chip devices. We have shown integration and control of heating elements on chip, the use of impedance spectroscopy to characterize tightly bound cell layers and innovative ways to employ electro-kinetic effects in nano-channels for the separation and concentration of proteins. Many more exciting examples could be given, such as (bio)sensor development and the integration of multiple microfluidic chips on a Fluidic Circuit Board (FCB). Electrical Engineering plays an essential role in all these topics, but only when working together with specialists from, e.g., the fields of chemistry, biology, physics or medicine is it possible to achieve the best results. This makes BIOS a fascinating multidisciplinary environment for students of various backgrounds, including but not limited to EE, BME, nanotechnology or physics to work in. If you're interested in broadening your scope and participating in cutting-edge research, please get in touch with the BIOS – Lab on a Chip group. As you may have noticed, the topics presented in this article are still open-ended and it's always possible to tailor a bachelor or master assignment in these or other projects to fit your skills and interests. Feel free to send an e-mail to Mathieu Odijk (m.odijk@utwente.nl), or Wouter Olthuis (w.olthuis@utwente.nl) and visit our website for more information: www.utwente.nl/ewi/bios/.

References

- [1] A. Manz, N. Graber and H.M. Widmer, *Sensors and Actuators B Chem.*, 1990, 1, 244-248.
- [2] G.M. Whitesides, *Nature*, 2006, 442, 368-373.
- [3] E.F.A. Brandon, C.D. Raap, I. Meijerman, J.H. Beijnen and J.H.M. Schellens, *Toxicol. Appl. Pharmacol.*, 2003, 189, 233-246.
- [4] M. Odijk, A. Baumann, W. Lohmann, F.T.G. van den Brink, W. Olthuis, U. Karst and A. van den Berg, *Lab Chip*, 2009, 9, 1687-1693.
- [5] F.T.G. van den Brink, W. Olthuis, A. van den Berg and M. Odijk, *TrAC Trends Anal. Chem.*, 2015, 70, 40-49.
- [6] R.M. Schoeman, *Droplet Microfluidic Platform for Cell Electrofusion*, University of Twente, 2015.
- [7] S.-Y. Teh, R. Lin, L.-H. Hung, A.P. Lee, *Lab Chip*, 2008, 8, 198-220.
- [8] X. Casadevall i Solvas, A.J. deMello, 2011, *Chem. Commun. (Camb.)*, 47, 1936-1942.
- [9] J.H. Leamon, D.R. Link, M. Egholm, J.M. Rothberg, 2006, *Nat. Methods.*, 3, 541-543.
- [10] L. Shui, A. van den Berg, J.C.T. Eijkel, 2009, *Lab Chip*, 9, 795-801.
- [11] <https://www.utwente.nl/en/news/!/2015/5/411001/albert-vanden-berg-receives-prestigious-erc-grant-for-the-second-time>, retrieved on 9-5-2017.
- [12] <https://www.utwente.nl/en/news/!/2017/5/118325/major-grant-for-organ-on-a-chip-research>, retrieved on 9-5-2017.
- [13] A.D. van der Meer and A. van den Berg, *Integr. Biol.*, 2012, 4, 461-470.
- [14] S.N. Bhatia and D.E. Ingber, *Nat. Biotechnol.*, 2014, 32, 760-772.
- [15] M.W. van der Helm, M. Odijk and F.T.G. van den Brink, *Maxwell (periodical of the ETV)*, 20.2, 28-30.
- [16] <http://carmichaellab.neurology.ucla.edu/subject/molecular-memory-systems-neural-repair>, retrieved on 19-12-2016.
- [17] B. Srinivasan, A.R. Kolli, M.B.

- Esch, H.E. Abaci, M.L. Schuler and James J. Hickman, *J. Lab. Autom.*, 2015, 20, 107-126.
- [18] M.W. van der Helm, M. Odijk, J.-P. Frimat, A.D. van der Meer, J.C.T. Eijkel, A. van den Berg and L.I. Segreink, *Biosens. Bioelectron.*, 2016, 85, 924-929.
- [19] M.W. van der Helm, M. Odijk, J.-P. Frimat, A.D. van der Meer, J.C.T. Eijkel, A. van den Berg and L.I. Segreink, *JOVE-J. Vis. Exp.* (accepted manuscript).
- [20] K. Benson, S. Cramer and H. J. Galla, *Fluids Barriers CNS*, 2013, 10:5.
- [21] S.H. Ko, Y. Song, S.J. Kim, M. Kim, J. Han and K.H. Kang, *Lab Chip*, 2012, 12, 4472-4482.
- [22] J. Quist, K.G.H. Janssen, P. Vulto, T. Hankemeier, and H. J. van der Linden, *Anal. Chem.*, 2011, 83, 7910-7915.
- [23] Q. Pu, J. Yun, H. Temkin, and S. Liu, *Nano Lett.*, 2004, 4, 1099-1103.

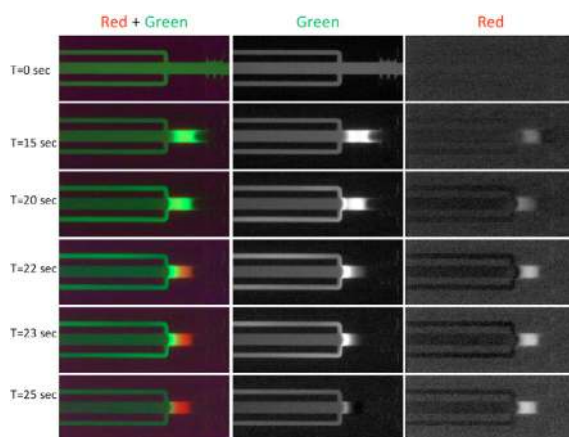

Figure 14. Two analytes are focused (red and green). The right column corresponds to the red filter/analyte, the middle row to the green filter/analyte and on the left is the composite image. When the focusing point is moved to the extraction channels, where a negative pressure is applied, one of the analytes can escape the channel.

Batavierenrace

Author: Casmilla Spaan

Every year the world's largest relay race takes place from Nijmegen to Enschede and what would EEsports be without making sure Scintilla could participate in this exciting event. But what makes these days so good? The answer lies within Sparks4ever, the participating team of Scintilla, because no run can be done without having fun!

It all began with the bus riding around Nijmegen, which is of course all you want to do from 10 in the evening till 7 in the morning. Luckily, with a lot of music, talking and eating and sometimes a little run we can all get through. However, when you have been awake from 4 in the morning it can get a little difficult sometimes, but with the help of your co-runners a little nap is always possible!

“Luckily, there is always a biker next to you to keep you a little company when needed.”

Even though it seems as if we only trained for having fun, that's not the case! We participated in running! Sometimes the other teams were running away from us, which could get a bit lonely. Luckily, there is always a biker next to you to keep you a little company when needed. When the race was over this was also continued into the late hours of the last day. Beginning with the Xelvin Bata barbeque together with our friends from Eindhoven: Thor and ending it together at the end party on the campus of the UT. It was a great weekend and EEsports can't wait to organise it again for you next year!



Junction

Author: Maarten Thoozen

Born in Brabant, studied Communication Sciences in Enschede, redacted a children TV show and much more. Kirsten Voncken tells about her life as a student, study advisor and everything in between.

I was born in Brabant, coincidentally near where Daphne was born, and I started my study here when I was 17, almost 18. I studied Communication Sciences and moved to Enschede when I started. My time studying here was a lot of fun. After I finished my studies I started working as a Marketing Communication advisor at an ICT company here in Enschede. One and a half year later I came back to the University of Twente, also at a Marketing Communication job, but more towards information for new students. I started at Physics and Chemistry, later at other studies like Health-related programmes and now at the EWI faculty. 50% of my time I am programme marketer for Creative Technology, Mathematics and Electrical Engineering. And 50% of my time I am study advisor, which I took over from Daphne because of her maternity leave.

Why did you study Communication Sciences?

Hmm, good question. Because it had my interest. At the time, I was interested in advertising. I wanted to know what makes advertising work, how do you convince someone of something. And it was about people, which I find interesting. My teachers in high school weren't surprised by my choice for Communication sciences. I was communicating all day long. I chatted quite a lot in their opinion.

Did you do an internship?

Yes, I did an internship in Paramaribo, Suriname. It was at a radio and television broadcaster called Sky, though it had nothing to do with the Dutch Sky Radio. I did a lot of different things there. I worked at the redaction of a kids show, something between Sesame Street and Klokhuis. I came up with items to film, I arranged the shooting of those items, I went with the camera crew and presenters and sometimes presented items myself. So that was part of what I did, mostly the practical things. My research assignment was for a new health education related program in rural areas of Suriname. I documented what kind of health issues were at play there and made an information program to tackle those issues. There were also a lot of other random things I did, a number of times I attended press meetings. I went there with a microphone and my laptop and made a report on the meeting, which was used to make news items.

My graduation internship also had to do with television, this time at the national public broadcaster. So that was in Hilversum. I looked at the programming for the television channel Nederland 3, to see what makes a good programming, and how good the programming for Nederland 3 is. A lot different from what I am doing now.

Interesting to hear, as Communication Sciences is quite different from Electrical Engineering.

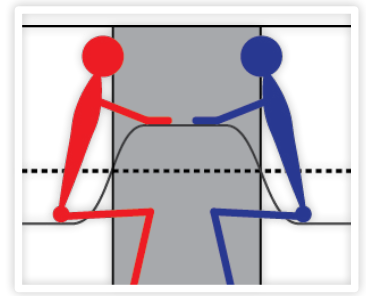

Yes, Communication Sciences is actually quite a broad subject. Television falls under mass communication, but also marketing, advertisements, but also corporate communication, how communication works within companies; how changes affect a company; how do the communication channels within a company work. For example, when the CvB wants to change something, how does that spread throughout the organization, or how does the communication from the employees to the management work. Those are all different aspects of Communication.

What kind of student were you?

A very busy and active student. I was active at the rowing association, Euros Roeien. I was a member of the board for that association in my second year as a student. I was also often coxswain, as I really enjoyed doing that. The coxswain gives commands to the rowers and determines the strategy and tactics during a race, and also physically steers the boat. I did that fanatically for several years. That is also where I met Daphne. Daphne's brother was also a member of Euros and was a fellow board member.

I was an active student and loved social activities. I had a group of friends at Euros, at my study, I had a very active house with which we did lots of things and I also still had a group of friends at home. I also did a lot of committees. Besides that, I also was a good student. I did a lot next to my studies, but also made sure I passed my exams.

What is your usual job?

I work full time, so 40 hours per week, of which half is being a study advisor and the other half is my old job as programme marketer. The goal of that job is to attract as many new students for the EWI faculty as possible, both for the Bachelor and Master programmes. Actually, the goal is not just to get as many students as possible, but also to make sure people are in the right place here, that they like their study. I guess your next question is: "so what exactly does that mean?". There are some practical things to my job and there are more strategical things. A strategical thing is what do we know of the market, in what countries are potential students, is that Indonesia, China, or more eastern Europe, Greece, or England? And also, what country fits what study, as that is not the same for all countries.

Another thing I do is gathering information about what kind of people visit our website; how many people do a 'student for a day' day; how are our open days; how many people have contacted us for information; what is the result of our marketing and how can we use that information to improve our marketing. A more practical thing I do is managing our website, updating texts on the website once a year, managing brochures, open days. For the open days, much of the work is done by the student teams and the coordinators for those teams, which is Lynn for Electrical Engineering and Lotte from Abacus for the entire EWI faculty. Most of it is done by the students, and I coordinate everything and help in case there are questions from

the students. Together with the studies I determine what kind of story we want to tell prospective students and what the message from the study is. Things like what makes the study unique, in what ways does it differ from other studies, how can we best tell that and how will it be received by the target audience.

How do you like being a study advisor?

I really like it. What I mostly like is the interaction with students and the feeling that sometimes I can really help. When someone comes in with a question, which can a practical question or a



Kirsten Voncken

Age

31

Favorite food

Lasagna

Favorite Drink

Tea

Favorite Color

Pink

problem someone faces which he or she doesn't know how to solve, it is very rewarding to notice that you can help that person just by asking the right questions. I like that. In my marketing job, you also work for the students, but it is way more indirect. It is mostly better organization you focus on, which in the end helps prospective students. But as a study advisor that interaction is more one-to-one, and you see the effect of your work more clearly. It also comes back to what my teachers from high school said, I really like holding conversations, so that I can hold nice conversations and that I get paid for that is nice.

What do you think of TEM?

I like that it integrates different subjects into one large module and the many projects you do. I had a few projects in my studies and those were the things I liked most during that time. I also think that is what I learned most from and they were also the most useful for my later career. Applying theory you learned in projects is one of the best ways to learn something, I think. So in a way I envy the current students, I wish I had as many projects as they do during my studies. However, I do see that students are under more pressure, as a study advisor you can really see that in the students. On the other hand, the study results are improving, so there are advantages and disadvantages, but I like the educational vision behind it.

What would you like to change about it?

That is a hard question. You could try to lower the pressure on students and that would help some people, but it would also be disadvantageous for other people. Some students need flexibility, but for other students the tight schedule is a good motivator. So it is not a clear cut that some students experience high pressure and therefore something should change. Personally, I think that is not the case, but I would like to see

a way to go through the studies in a bit more flexible way for students that need that for whatever reason they are not able to do it normally. But there already are ways to do that now, so I don't see a reason something should change.

What do you think is the best Electrical Engineering module currently?

That is a bit of a hard question to answer after only a short time as study advisor. In terms of educational content, that is hard to say for me, I don't really have an insight into that. But as a student I would be really interested in module 11. That does not necessarily mean it is better than other modules, but I imagine that after two years of Electrical Engineering modules and half a year of minor it is nice to do a large group project before you bachelor thesis. It is a nice way to integrate all your knowledge into one large design based bachelor assignment.

What are your hobbies?

Food! Much and tasty food. Since a year and a half I live in Zutphen, were I bought a house together with my husband with a large garden, and I like tending to that garden. It sometimes gets overwhelming with all the plants growing, but I like gardening. Furthermore, I like doing fun things with friends and family. That also includes eating, having a nice meal, a glass of wine and afterwards nice chatting or tasty snacks, just a nice party together. Nowadays I don't row anymore, but I have always enjoyed being coxswain.

What is your family situation?

I live together with my husband, we don't have children. We bought our house two years ago and we renovated it together. I painted a lot of window frames and walls in the past two years. There was a lot that had to be done to

that house, and recently we had a large remodelling of the ground floor. Before that we remodelled the upper floor, and we also worked on the attic. So doing DIY stuff together with my husband in and around the house can also be seen as a hobby.

What keeps you up at night?

Literally, my husband snoring. But I have ear plugs for that now.

What would you like to do in the future?

Finishing our house. We are still not completely done with that. And I'd like to make our garden even more beautiful. I would also like to become a good study advisor. This is a temporary job, Daphne returns in July, but I would like to develop my study advisor skills more. It is a lot of work to improve that, to feel even better what students struggle with, what people need when they come in, with what you can help people and how you can do that in the best way possible. I would like to learn more about that. Other than that, whatever the future holds. I have a lot of plans and ideas, but the two things I told are the most important ones.

Do you have a piece of advice for the students?

That is a College Tour question! They always end with that! But I would say enjoy your time as a student. With that I don't mean go to the bar and enjoy a lot of beer, but enjoy your time as a student and all the possibilities to try new things, to learn about the subject you are studying, develop yourself and get to know yourself, just enjoy the entirety of student life. I can imagine there are things that feel like a burden, and there is a lot of pressure on students, but learning new things also has a lot of nice aspects, which I think one should enjoy.



Dap(h)ne!

MOTEQ Re-engineering challenge

SCALA Summer BBQ

Kandi-drink!
UNIVERSITY OF TWENTE.

End-P BBQ

Moteq Re-Engineering Challenge

2017 Edition

April 21st marked the start of this year's Moteq Re-Engineering challenge. A total of eleven teams gathered to learn about the ins and outs of the challenge. The teams paid close attention as the committee unravelled the 3-staged track that the contraptions would have to complete. A tough challenge in which both the robustness and the controllability would be put to thorough tests; the contraptions had to descend the three steps in front of the Zilverling, follow a pre-set parkour including some off-road sections and complete their track by transporting a small ball up the slope.

The versatility of the challenge demanded properly designed systems. Luckily, the opening drink proved to be the perfect opportunity to get familiar with the challenge, do some brainstorming and think of all the weird, awesome and dope contraptions that could potenti-

ally complete the challenge. Strategies were drafted and wish lists were compiled that would serve as a plan to storm the scrapheap as efficiently as possible the next morning.

That very morning, the team captain



Author: Stef van Zanten



of every team lined up in front of the heap and waited for the committee to mark the official start of the challenge. As soon as the green light was issued by Lars, the chairman, the team captains stormed the pile full of printers, scanners, computers, docking stations, ser-

"As soon as the green light was issued by Lars, the chairman, the team captains stormed the pile..."

vers and tons of other electronic scrap. Other team members were ready to bring the collected scrap to their team's workbench and once the team captains convinced themselves that there was no more useful scrap on the pile, an enormous collection of tools was put to



good use. Casings were demolished and the teams collected the various pieces of useful electronics so that they could be combined to construct the winning contraption.

After some hours of extensive destructive behaviour, it was time to recharge during the lunch. By now, the ultimately cool ideas from the previous evening might have already been discarded, but

"By now, the ultimately cool ideas from the previous evening might have already been discarded."

new ideas will have formed. The teams continued constructing their contraptions in the afternoon and switched from destruction to construction (although some teams probably enjoyed it too much to stop). The Chinese takeaway that was available for dinner was a welcome break from all the dust, noise and bad smells in the W-zaal and after another two hours of construction time a drink concluded the day. It offered the team members the option to boast



The competition proved that the challenge was tough, there were only a few contraptions able to finish the entire track, while some did not even make it past the stairs. The atmosphere, however, was awesome as the sometimes hilarious actions of the contraptions were a funny spectacle to behold. To name an example: one of the contraptions was short-circuiting leaving the team puzzled as to why that was until someone cleverly pointed out that it would probably have to do something with the smoke drizzling above their circuit... All in all, it turned out to be a great weekend and on a personal note I would like to thank the committee and congratulate the winning teams!



ASML:

Where technological progress has far-reaching benefits. Be part of it!

Author: ASML

These days, a small USB stick costing only €10 can hold up to 16 GB of data. In hospitals, a camera the size of a pill can be swallowed to survey a patient's intestines. Modern pacemakers, critical devices that control abnormal heart rhythms, are now less than a tenth the size of earlier ones. And in the oceans, tiny GPS transmitters track endangered turtles to help protect them.

While these devices are incredibly small, they represent a big milestone in technological progress. At the heart of each of these life-enhancing innovations is a microchip – a tiny package of integrated circuitry that powers the performance of the device.

In a world in which major breakthroughs measure only a few nanometres in size, the constant quest is to produce chips that are smaller, faster, more effective and less expensive. One of the major high-tech players leading the quest is ASML, a manufacturer of lithography systems for producing computer chips.

Crucial step

ASML, located in Veldhoven in The Netherlands, supplies equipment to all the world's major chip manufacturers. These include Samsung, Intel and TSMC.



There are dozens of steps along the path to producing a chip. ASML helps manufacturers take just one of these steps, but it's a very crucial step: lithography. Lithography involves exposing and chemically etching the wafers used to 'print' a chip's components. The more accurate the lithography process is, the smaller the resultant microchip can be.

Using ASML's latest generation of machines, it's possible to print lines on chips that are only about 20 nm thick. To put this into perspective... that's like printing the contents of a 500-page novel onto a centimetre-long strand of human hair!

Opportunities to be part of progress

The driving force behind ASML's technological breakthroughs is its forward-thinking engineers. ASML's more than 16,000 employees are some of the most creative thinkers in the world of physics, mathematics, chemistry, mechatronics, optics and informatics. And because ASML invests over €1.0 billion annually into Research & Development, these experts have all the resources at their disposal to push progress to the extreme. It's the only way ASML can maintain its edge – worldwide.\

ASML

Be part of progress

A place of learning

ASML is an ideal environment for professional growth and development. The company offers a fulfilling career, not just a job. ASML rewards employees competitively and provides coaching, training and personal career development. Flexibility, enthusiasm, ambition and customer focus are the foundation for a world of opportunity. To find your opportunity, visit www.workingatasmil.com



On Location

Super secret SKIC camp-site visit

Author: Matthijs van Minnen

It might have gone unnoticed, but the preparations for the Kick-In of next year are in full swing. People on all levels of the University are putting many hours into making the next Kick-In the best one you have ever seen. Undoubtedly, Scintilla cannot fall behind. Since the start of this lecture year the SKIC has been working full force on preparing the Kick-In camp. Besides the awesome theme, we have made numerous other preparations. This includes scouting the super duper secret campsite.



At the end of March a few committee members got into a car and set out on their journey to a town/city not far from (but also not necessarily close to) Enschede. If you want to trace their footsteps, just follow the black fumes (the old Volvo is not very friendly to the environment). Luckily that smoke has cleared, making it much harder to find a direct route towards the campsite.

the tour was the small glimpse into the forbidden room, of which the content will remain a secret.

“5/7 perfect campsite!”

In August, the Electrical Engineering students to be have to venture their way around Twente on a quest to find the

campsite. They will be guided, although the instructions might be unclear at some points. All in the name of team building, naturally!

*This is Cora Salm's estimate and this is considered holy as in the past few years she has made incredibly accurate estimates, only deviating by 3 or 4 students.

“10/10, would visit again!”

- Fluttielje Admiraal

After an exciting ride, to say the least, our group of SKIC members arrived at 'the location' to be greeted by the building manager. The man in question was very kind and showed us around. He pointed out important locations, such as the perfect spot for the mobi-tap as well as After which the SKIC members walked by all the sleeping quarters which can easily house the expected number of students: 82*, their parents and the 'oude-lullen'. The highlight of



The passing of a programme director

Authors: Jippe Ros-
sen, Mark Bentum

Over the years he has built quite some reputation at the university of Twente. Whether it is his endless passion for antennas and RF, his immense enthusiasm for teaching, or just because he is a really nice fellow, pretty much anyone in the department of electrical engineering knows him: Mark Bentum.

He has been the program director of Electrical engineering for three and a half years. Unfortunately, the editorial team of *The Vonk* got word that he will be leaving us soon. Because of all his contributions to the association and the program, it seemed only right to put him in the spotlights one last time. Therefore we planned a meeting and interviewed him about the best and worst memories at Twente and as the programme director of electrical engineering.

What were the highlights for you as programme director?

That must be the accreditation results. Some 6 years ago the accreditation committee was very skeptical of some aspects of the bachelor programme. If these were not improved in the last few years, we all would be in great trouble, which is of course the last thing anyone needs. After years of hard work the committee visited us again and they

were luckily mostly positive. We passed with some minor sidenotes (which we can further improve on) but last week we got the final report which confirmed the earlier findings.

Another highlight of my career was that the master programme got assessed as exceptional, which means it is seen as one of the best of the country. This is a major compliment to everyone involved as it is an acknowledgement of all the hard work. But Personally I think it also



very important that the work field is happy with how we perform. I observe that companies really like to have students from our university.

The ultimate goal of everyone working here is to give young bright minds the opportunity to gain knowledge and to assist them in that. When you achieve just that, that is a great feeling.

To what extent are you in contact with companies then?

As a programme director by nature not much, I initialized an advisory committee consisting of influential persons of some esteemed Dutch companies (for example ASML and Philips). In our bi-annual meetings you sometimes hear such positive signals.

In my research projects I extensively cooperate with some major companies. In these collaborations I obtain much more feedback. The opinions from those entities are solely positive! The companies our students do internships at, also indicate that our students are great to have aboard.

“The ultimate goal is to give young bright minds the opportunity to gain knowledge and to assist them in that.”

What were some of your all time lows?

The thing I hated most was to terminate students from the programme. With the binding recommendation this is unavoidable, but it is a tough pill to swallow to terminate someone who tried his best and put loads of effort in, but just did not get the right academic level. This is also something which I cannot do anything about, it is a decision instated by the government. Here in Twente I tried to put the threshold as fair as possible. It should be that if you just make the cut, you should be able to succeed in the rest of the programme. However if you only just make it, you have got to prepare yourself for some tough years.

You mentioned some restrictions put on you by the ministry, were there ever occasions you wanted to contact your colleagues in Eindhoven and Delft to revolt against the ministry?

Of course I am in contact with the other programme directors, but not concerning those restrictions. A topic I did consult them on is that the minor went from 20 to 30 credits. I was not a big supporter of that. Luckily I did manage to make it possible to go more in-depth into electrical engineering instead of broadening your skills. I am very pleased about that.

“The thing I hated most was to terminate students from the programme.”

How popular are those in-depth tracks?

Very popular indeed. Loads of students pick minors in Cyber Physical Systems, Lab on a Chip or start a project such as Green Team or Solar Boat.

We heard that you were going to leave us, do you have any plans?

Well actually, that is the reason why I am leaving. I got offered a full professor position at the university of Eindhoven. I gave this quite some thought and finally decided to take it. This also enables me to put a bit more focus on Astron. I will be spending three days on the university of Eindhoven and 2 days at Astron. This however results in me not being the programme director at Twente anymore.

How will this impact your work?

Well, currently I spent two days a week doing tasks related to my position as programme director. In total I spent about three days a week doing meetings with students or staff members, which is just part of being a programme director. In the future this will not be the case anymore so I can focus my attention much more on my research. I love doing those meetings, but yes, my work will be very different indeed.

How will this affect your personal life?

Well, currently I live in Beilen, Drenthe. This is very close to Astron. I have thought about moving, but if you live somewhere in between you have to travel every single day. Now I can go to work by bike on two days of the week. When I will be in Eindhoven I will go by train, This enables me to also get some work done then. Also I did not wish to uproot my family.

What are you going to miss most?

Well of course I am going to miss a lot of things. My colleagues, the atmosphere here in Twente, the individual conversations in the hallways with students and of course also the relation with Scintilla. I have enjoyed myself so much here in Twente. This is also very important as I used to be in the car for two hours a day to get here and go back. If you do not enjoy it completely, it will eventually break you. However I will be starting something new soon. It is scary of course, but I felt like I cannot refuse this to myself. So I we will see how it turns out.

You mentioned a while ago that you are currently spending most of your time

in meeting, however you are also indicating that as something great just now, what is your view on that?

You are absolutely right. I am currently literally not in charge of my own agenda. It is always completely booked which hardly leaves any time to pretty much do anything else. Replying to emails I have to do at night because during the day I do not get to it. After this I have another meeting and to be honest I do not even know what is it about just yet. Even during the lunch I have meetings! Soon that will all be a thing of the past, I wonder what that will be like. I am afraid I will be going to miss my hectic life, but we will see.

As a programme director you also have to deal with the programme committee, how did you experience this collaboration?

With the program committee? Very pleasantly! I like to be challenged by students who dare to speak up and try to change things for the better. Not that they just want to be defiant, but they dare to speak up to criticize the

“I am currently literally not in charge of my own agenda”

program to improve the quality. This is also very beneficial for the programme, as it is very valuable input. It is a good thing that we do not always agree with one another. If that were the case, there would not be any progress, which might result in us missing out on necessary changes. Besides that, I just love to be in discussion about educational topics!

Soon a pilot is starting on



an elected programme committee, how do you view this development?

For the students party I think this is a great thing. By doing this you are likely to end up with only the most motivated students, which will probably result in also the most valuable input. However, for the staff part I am very wary for some nasty issues. I agree that the committee should not be ‘an old boys network’. Being a researcher and or teacher is a very tiring position. You have to excel in education and research, this is also on what you are assessed. I feel that electi-

“The discussion on whether or not to split the modules into sub modules led to very divided views.”

ons might make the job of being in the programme committee too much of an optional task and that problems will arise of us not being able to fill up all the positions in such bodies. And with that I also mean the educational quality

committee and the exam committees. I fear that people are more likely to say yes when I ask them to join the committee, then when they are not asked personally to candidate themselves.

“It is a good thing that we do not always agree with one another”

But is not then the alternative that the programme committee can decide who has to criticize his own judgements?

Yes that will be the result, but I can hardly believe that any programme director will think: “The programme committee, it would suit me to never have them question my judgements”. I honestly think we have to keep improving the programme. To sometimes have someone step on your toes or question you is just part of that.

Was there a particular topic discussed in the programme committee that stands out, for the better or for the worse?

Well, most hard topics are very personal and are therefore classified to within the committee. But one of the most chal-

“I have said in the past that I would never be the programme director and look at me now”

lenging discussions I have had is on the topic of the Twente Educational Model. The discussion on whether or not to

split the modules into sub modules led to very divided views. Fortunately we could come to an agreement in the end.

Will we ever see you again in Twente?

Heh, I cannot rule that out no. I have said in the past that I would never be the programme director and look at me now. I honestly do not know, of course I will visit the university of Twente now and then. There is quite some joint research between Eindhoven and Twente. To obtain large research projects you hardly can do that alone as a university these days. But it is not my intention to end up with an official position here in Twente.

Another question we love to ask in these kind of interviews is, do you have any last lessons or views you want to pass on to those you leave behind?

Well, that’s a tough one. I think it is the lesson I already said before. We have to stay wary of the situation we are currently in and always look for the way forward. Not that I feel like we are doing a bad job now, but we have got to keep this in our minds always. There has been a situation in the past where this was not the case and the easiest path was taken, instead of the path that was necessary. At some point it even happened that the education was not the highest priority. You just cannot have that.



Girl Troubles

Author: Marissa Jonker

‘How many girls are doing your study this year?’ is a question many people have asked me. The answer to that question: a handful. Actually, while I’m writing this piece of text, there are three girls left, including me.

One thing mentioned quite frequently when applying for this study, was the small amount of girls. I did not think it would be that much of an issue, so that fact did not hold me back from applying for this study or anything. There was even a separate so called ‘Ladies-Kick-In’, before the actual Kick-In took place, so we would at least have some lady

“When the actual Kick-In started, I remember I was a bit blown away by the girl-boy ratio”

friends from other studies, or from the study we were going to do, before being thrown into the boys-filled environment. When the actual Kick-In started, I remember I was a bit blown away by the girl-boy ratio.

Fortunately, the do-group I joined mainly consisted of girls, which was nice.

At the beginning of the actual college year, everything was pretty normal, that is, it felt just like high school. I already knew some people from the Kick-In, which was nice. At that point, I don’t think I was treated any differently by my classmates because of the fact I was one of the few girls in class. However, when there are as few girls as there are, it does

feel kind of like you don’t belong there and you have to prove yourself. Even now, almost at the end of my first year, I sometimes still feel like that. I try not to get bothered by it too much, though.

Eventually, I decided to join committees, where I made some good friends. At one point, the only people I hung out with were boys. It doesn’t sound bad, but I did long for female friends. Luckily, all my housemates are girls, so that problem was somewhat fixed. I also joined a sport’s club, where I met lots of other people.

The image I’m sketching might not be that positive, but I’m just writing this from my perspective and experiences. At least there are some ‘positive’ aspects too. Some teachers actually give you

“Some teachers actually give you more attention and are nicer to you than they are to other students”

more attention and are nicer to you than they are to other students. Also, male classmates seem to pity you more if you’re in trouble, so they’re more likely to help you. I must say, I have not really noticed any other ‘positive’ aspect of being a girl in EE. It’s mostly just like



being in high school and you get treated like any other student.

It’s a pity there are just a few girls, but in the end it’s about the study and whether you like it or not. If you really like the

“If you are in the same situation as me and you would like to meet more girls, I would suggest you join a sport’s club, or some other kind of association”

study, it does not really matter if there are just a few girls. Furthermore, guys won’t necessarily treat you differently than the others. Maybe they pity you more, but I guess that has always been the case. Also, if you are in the same situation as me and you would like to meet more girls, I would suggest you join a sport’s club, or some other kind of association.

Excursion to the Grolsch Brewery

Author: Nabuel Manterola

The fifteenth of May, Scala organized an excursion to the Grolsch brewery. A large part of Scintilla is suddenly interested in activities when beer is involved, so we left with a group of 40 to go to ‘heaven on earth’.

The day consisted of three parts: a tour through the several stages of the brewery, a challenge in which points could be earned to put Scintilla high on the scoreboard and an hour of free beer.

The Tour

The tour started in the actual brewery, where we were told a lot about the process of brewing beer at Grolsch and got an idea of the sheer size of the place. The main tank could process 85.000 litres of beer at once, and the factory had a maximum production of 1.8 million litres a day. Then, we passed through a hall full of Grolsch posters and commercials. The guide proudly told us about the main slogan which has been around since the 1960s. Afterwards it was time for the part electrical engineers enjoy most: the bottling. Huge conveyor belts transported all kinds of bottles and cans through the system, which unpackaged, cleaned, filled and repackaged every unit. All these bottles are stored in a large warehouse, which is very, very large. Large as in, you could get lost for an hour. No, seriously, this thing is massive. And what’s even more impressive is the fact that the whole warehouse

would be empty in a week if production was halted.

The challenge

Back in the main bar, Scintilla had to defend its honour in three challenges. First each of us was presented with ten questions about Grolsch, of which most were easy to answer by just looking at some ads in the next room. Then, two volunteers had to attach as many flip-tops to bottles in two minutes. Finally, two members of the Borrel were selected for the final challenge: pouring the perfect beer with perfect technique. There was quite some discussion between our Borrel and the Grolsch organization about how perfect technique looks like, but

this exercise still earned us quite some points.

The beer

Finally, the most important part of the visit: an hour of free beer! Even though just about any beer Grolsch makes was available, we spent very little time exploring the several Radler 0.0% flavours and focused more on Herfstbok, Weizen and a brand-new beer which is not yet available in most stores: the Grolsch Weizen-IPA. After about an hour we were sad to hear time was up. We didn’t go home empty-handed though, but with a goody bag containing two Grolsch glasses and a 1.5L bottle of beer.



Datasheet 2.0

After trying all the recipes from last Vonk, I'm sure you're dying to try some more things. This time there are recipes for two main courses, so you don't have to eat the same thing every day anymore, greatly improving your quality of life and general happiness.

mEExican (Mexican oven dish)

A very easy dish that every student loves (even my parents love this student dish). Whenever you are in a Mexican mood but do not want burritos or something like that, choose this! Can't say much about it, just try it yourself and love it.

- Ingredients (4 persons):
- 300 g Rice
 - 500 g Minced meat
 - 350 g Mix of beans

- 150 g Corn
- 1 Bell pepper
- 400 g Tomato
- 1 bag Mexican seasoning mix (burrito, fajita, etc.)
- 200 g Crème fraiche
- 1 bag Tortilla chips
- 200 g Cheese

Optional:
Jalapeño peppers



Author: Céline Steenge



What to do:

1. Cook the rice like it is stated on the package and heat the oven at 200 degrees Celsius
2. Chop the vegetables
3. Heat the oil in a pan and bake the minced meat
4. Add the seasoning and tomatoes and bake it for another 2 minutes.
5. Add the beans, corn and bell pepper to the minced meat and tomatoes
6. Fill the baking dish first with rice, then with the meat and vegetables, next the crème fraiche, followed by the tortillas and finish with the cheese (optional the jalapeños are added before the cheese)
7. Put the baking dish in the oven for 20-30 minutes till the cheese is nicely golden

Mixed signals (Oven dish with macaroni)

This is really the easiest yet varying student food ever. When this dish is made at my house, there is always way too much food yet the price is low. Everyone can make this so show off next time you cook!

Ingredients (4 persons):

- 450 g Macaroni bows
- 3 Bell peppers
- 2 Leeks
- 1 Canned ham
- 250 mL Cooking cream
- Cheese
- Herbs

Optional:

- Pieces of bacon

What to do:

1. Cook the macaroni like it is stated on the package and heat the oven at 180 degrees Celsius
2. Chop the vegetables and ham
3. Heat the oil in a pan and bake the ham and the vegetables (and the pieces of bacon)
4. Add some herbs like parsley, coriander and thyme.
5. Oil the baking dish to make sure nothing sticks.
6. Fill the baking dish first with macaroni, vegetables and ham and mix everything nicely.
7. Pour cooking cream over the mix and mix even more!
8. Add the cheese on top of the mix
9. Put the baking dish in the oven for 10-15 minutes till the cheese is nicely golden



LEDs (coconut macaroon)

Do you want fast cookies for your house or parents? This is the answer! You only need 3 ingredients and it is ready in 30 minutes!

Ingredients (16 cookies)

- 4 Eggs
- 200 g Granulated sugar
- 200 g Shredded coconut

What to do:

1. Heat the oven at 175 degrees Celsius
2. Separate yolk and egg white and put the yolk in a bowl
3. Mix the yolk, sugar and coconut



4. Heat the mix during 3 minutes at a middle high fire (the mix should not change colour!!!)
5. Use two spoons to make 16 coconut macaroons on baking paper. Make sure there is 3 cm distance between the coconut macaroons.
6. Bake the coconut macaroons for approximately 20 minutes till they are nicely gold.

Ingredients (20 muffins):

- 2 Eggs (Medium)
- 125 ml vegetable oil
- 250 ml Milk
- 200 g Sugar
- 400 g self-rising flour
- 1 tsp salt

Optional:

- 100 g chocolate chips or dried fruits or nuts

What to do:

1. Heat the oven at 180/200 degrees Celsius
2. Beat the eggs lightly in a large bowl for 1 min
3. Add oil and milk and beat until combined
4. Add sugar and whisk till the mix is smooth
5. Sift the flour and salt and mix again till the mix is smooth (do not mix too long! This will make the muffins tough)
6. Fill the muffin cases for two-thirds
7. Bake 20-25 minutes until risen. You can check whether the muf-

ins are ready by putting a skewer in the middle. When it comes out clean, the muffins are ready!

Variations:

When the mix is ready, add chocolate, fruit, nuts or everything to have more than just the normal muffin!

These were the recipes of this edition. When you feel like sharing your recipes, please mail them to vonk@scintilla.utwente.nl!

Sources:

mEEexican: <https://nl.pinterest.com/pin/275564070920883985/>

Mixed signals: <http://www.smulweb.nl/recepten/1416711/Ovenschotel-macaroni-prei-paddenstoelen-kaas-ham>

LEDs: <http://www.thekitchn.com/how-to-make-easy-coconut-macaroons-cooking-lessons-from-the-kitchn-186918>

Capacitors: <https://www.bbcgoodfood.com/recipes/2331641/basic-muffin-recipe>

Capacitors (muffins)

Making coconut macaroons is easy but maybe you do not like them. Therefore, another easy baking recipe which is just as fantastic! Make your own muffins within an hour.

Link the baby!

Author: Truusje

They sometimes say that everything used to be better in the old days. Personally I could not agree more. All the issues you hear nowadays were not even possible back in the day.

One of the most annoying things is fake news. Since social media became a big thing you cannot trust anything anymore.

To escape these pesky issues, I volunteered some fellow electrical engineers to build me a time machine. After some minor complications I succeeded to travel back to 1998.

Unfortunately this also means that our new candidate board is still walking

around in diapers. As I still need to congratulate them on their new acquired titles I need to be able to keep them apart.

As this is significantly harder than building a time machine, I desperately need some help with this. Can you help me link each baby photo to the correct candidate board member? Please send in the correct combinations to vonk@scintilla.utwente.nl.

By the way, the last editions puuzle was succesfully solved by Pepijn Eikelmans. Congratulations! You will soon be contacted by the Vonk to claim your prize!



1



2



3



4



5



From left to right: Stef, Friso, Bas, Koen, Gino, Olaf



6

**We push
technology further**

**to print microchip features
that are finer**



**to make the
energy use of
a battery more
efficient**

**to make electric
cars the standard**

Do you dream of changing the world of innovation? Do complex technological challenges appeal to your imagination? We are looking for you. ASML always wants to get in touch with eager and curious students.

Join us at [workingatasmil.com/students](https://www.workingatasmil.com/students)

ASML

Be part of progress